

SCHEDA per la

Percezione visiva:

- colore 2 sch.
- forma 3 sch.
- colore e forma 4 sch.
- posizione 6 sch.
- posizione e colore 2 sch.

TOT. 17 schede

00001

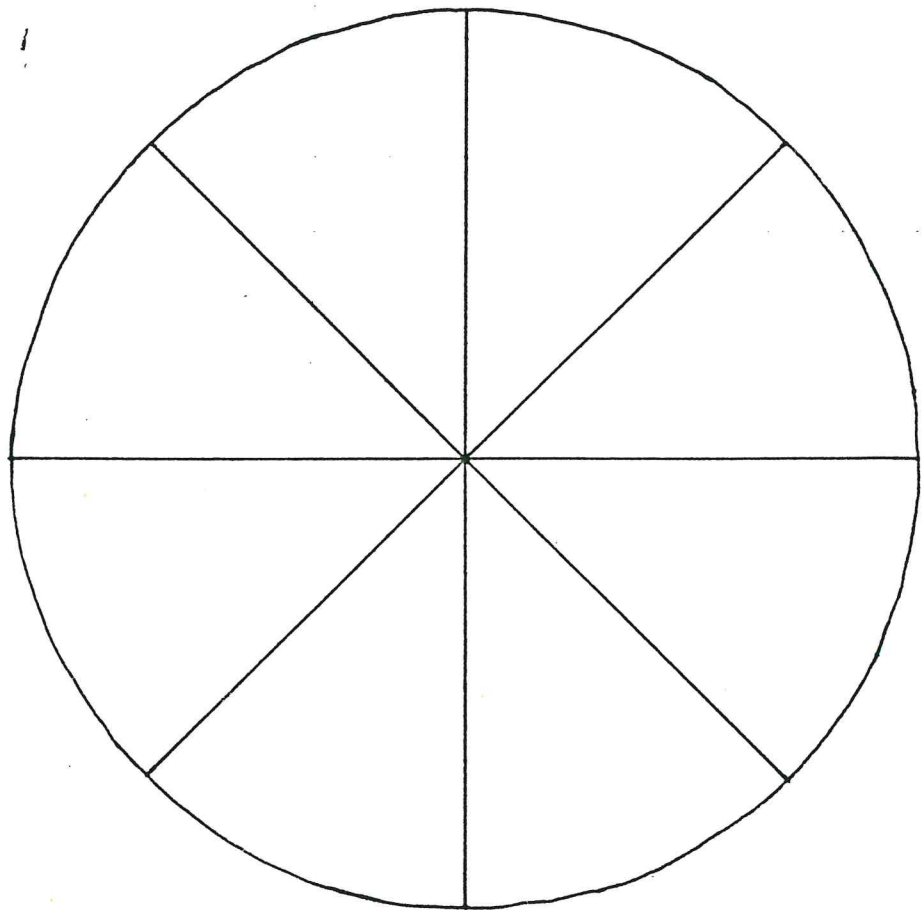
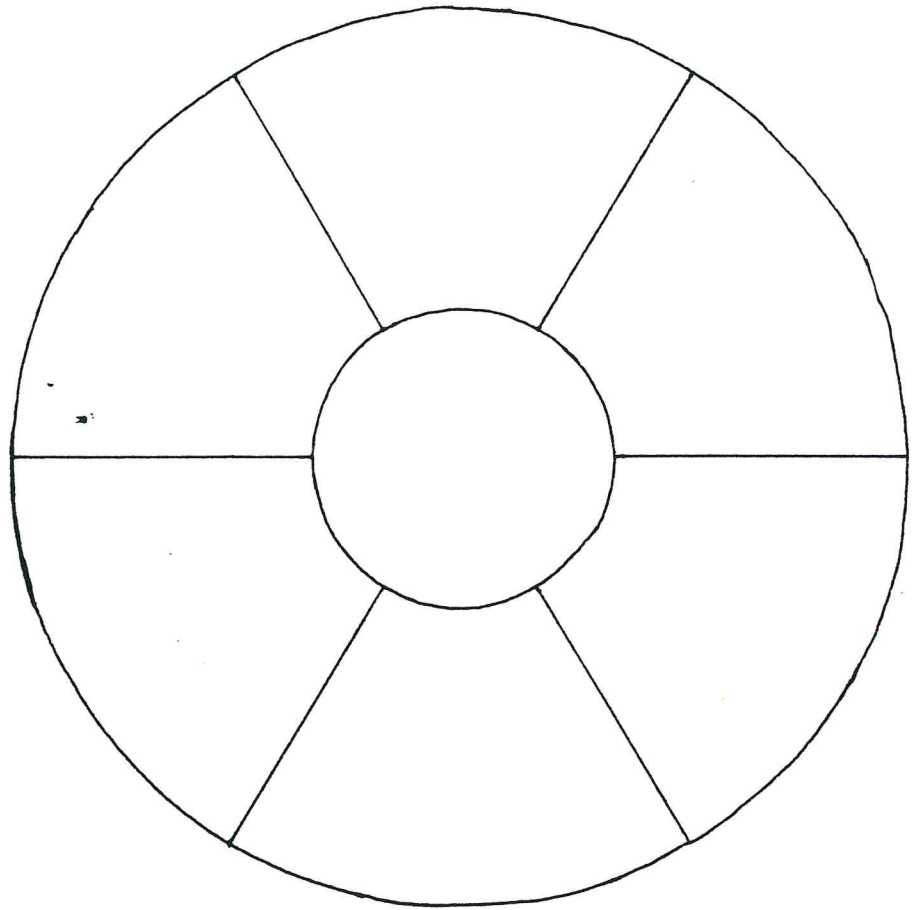



QUADRATO

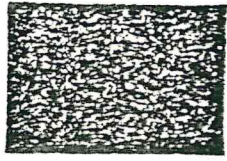

RETTANGOLO



CERCHIO



TRIANGOLO

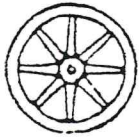
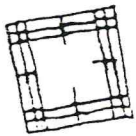

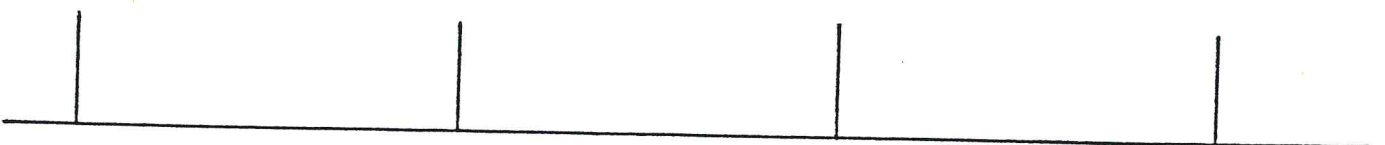
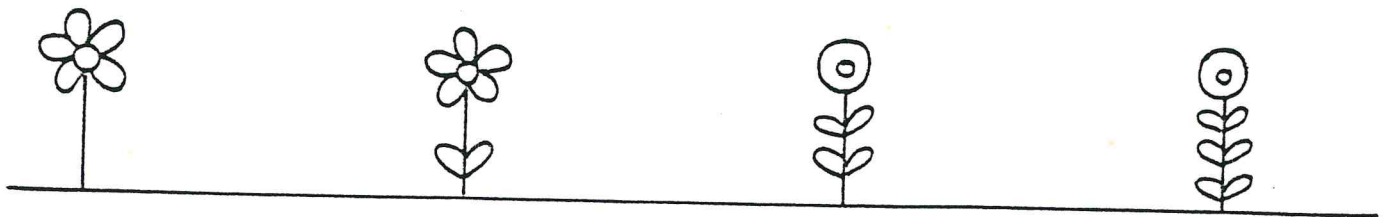
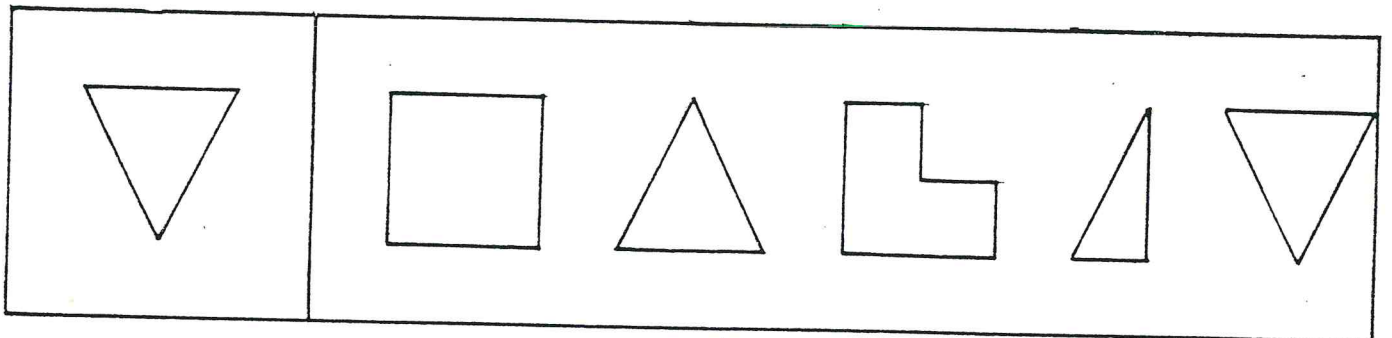
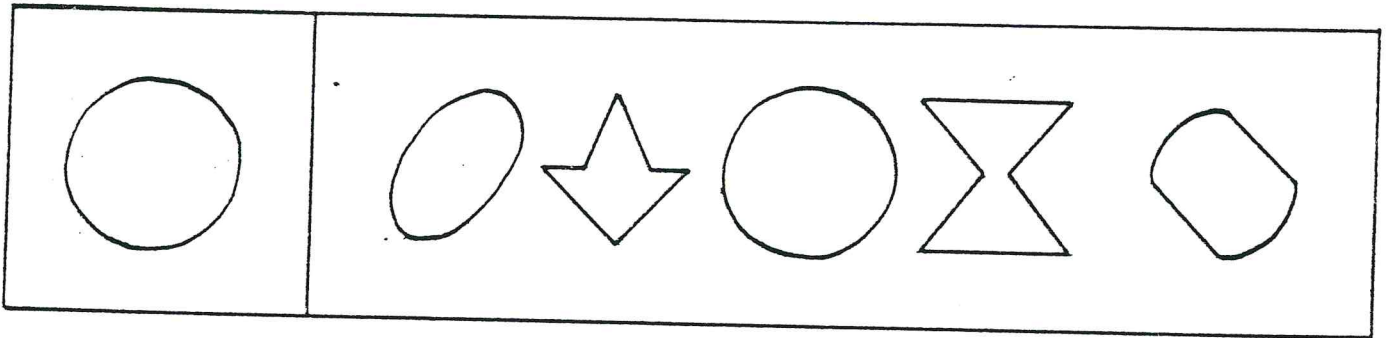
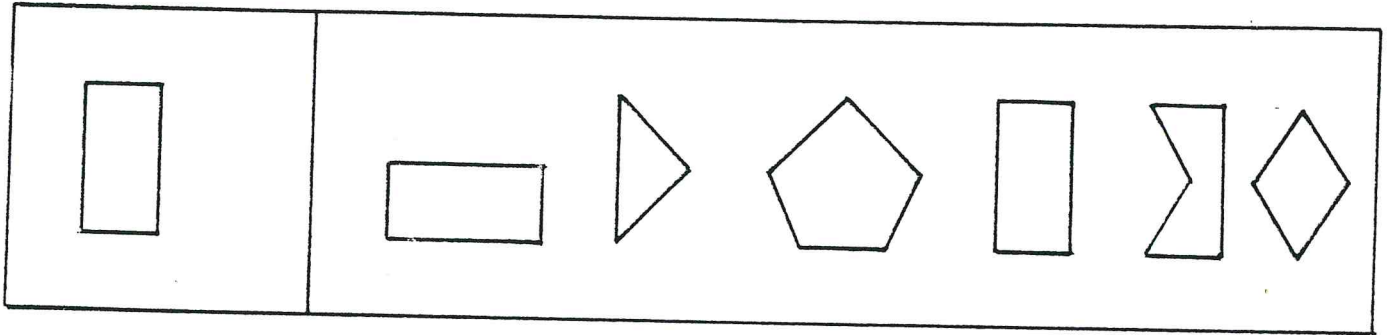
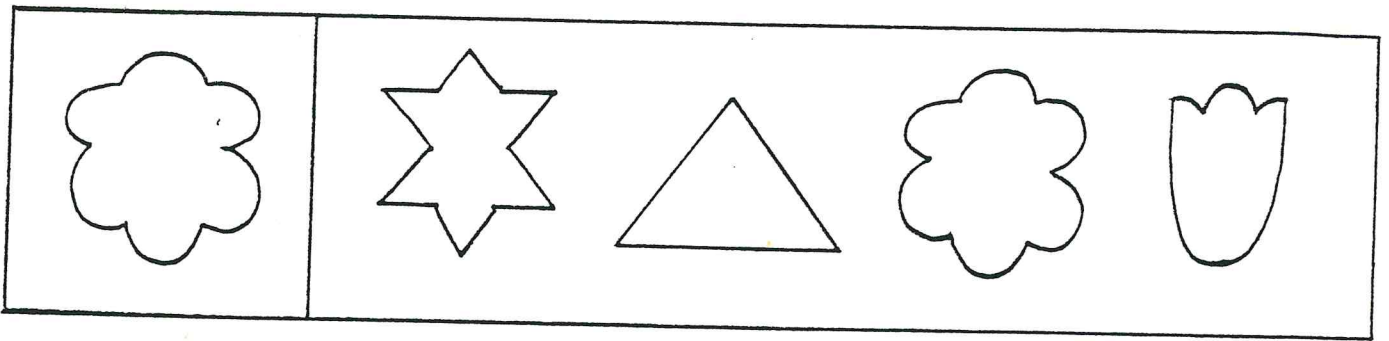

Rosso	R.
B.	G.

	△
○	□

▭	△
	□

▭	
○	□

	△
○	

▭	
	□

	□

▭	

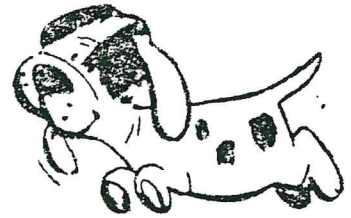
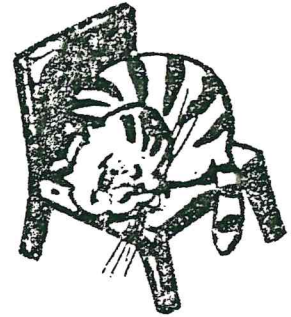
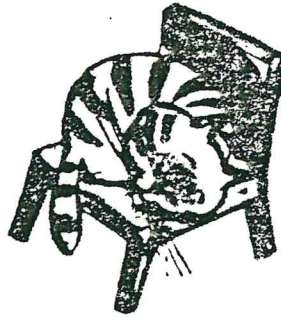
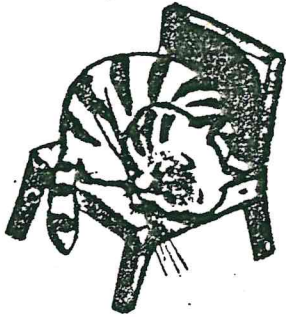
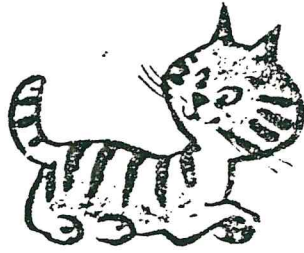
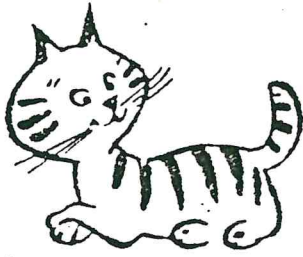



P

p

b

q

P

P

Insiemi:

- insiemi omogenei ed eterogenei + schede

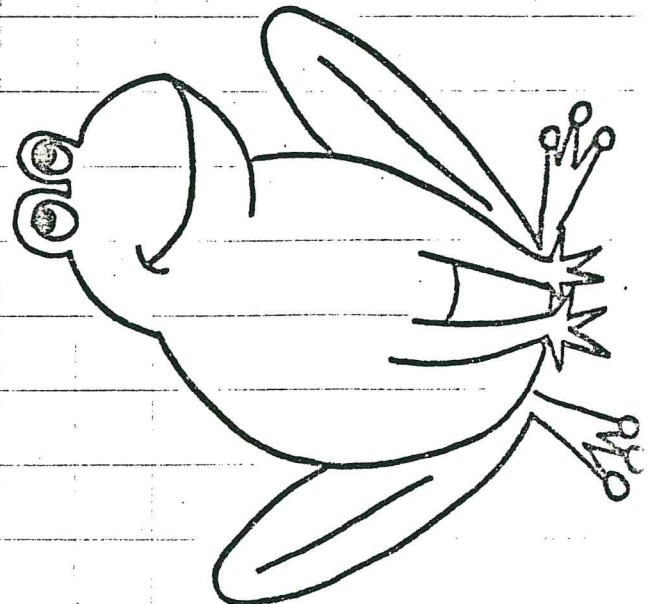
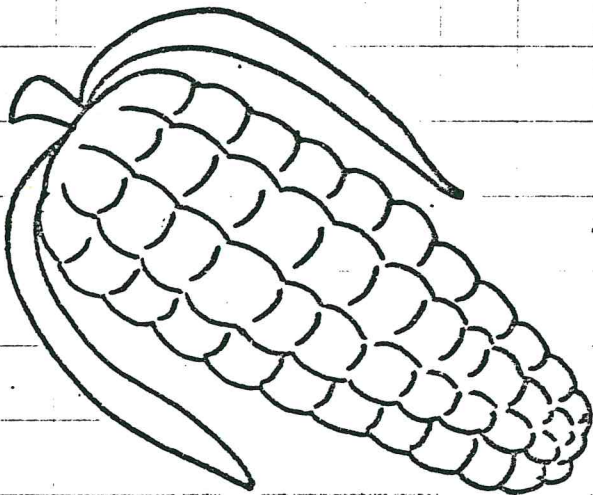
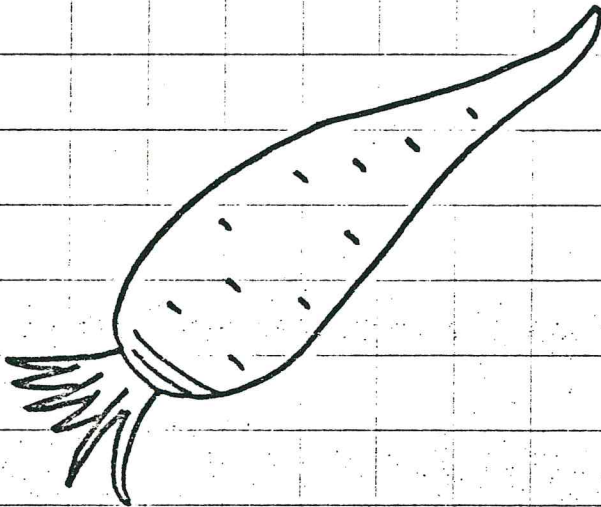
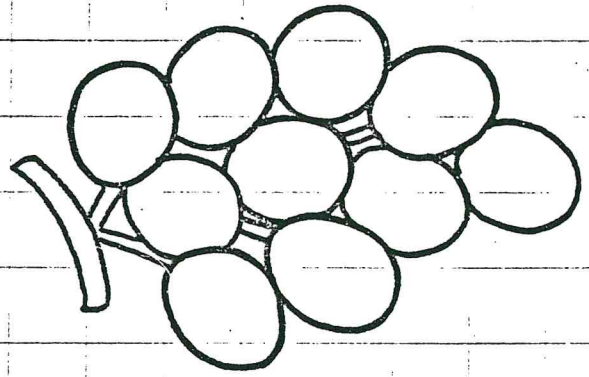
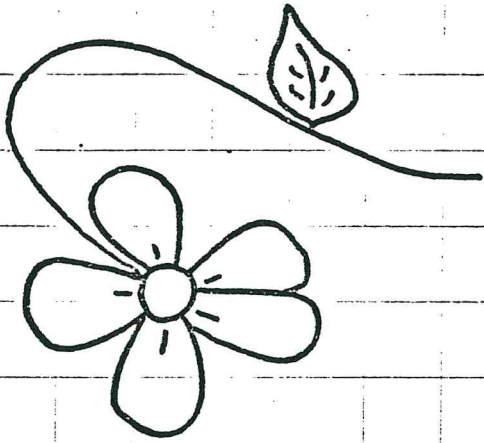



GLI INSIEMI

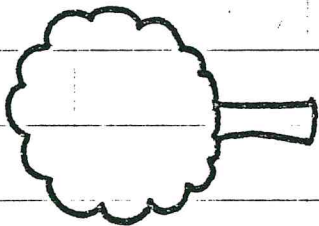

DISEGNA

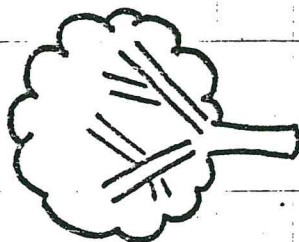
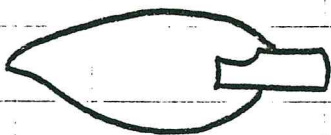

DISEGNA GLI INSIEMI

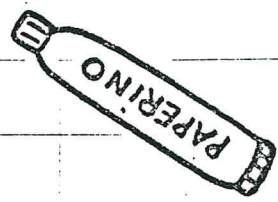
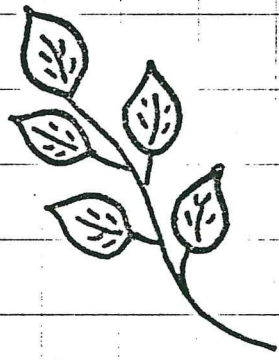
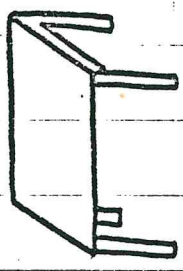
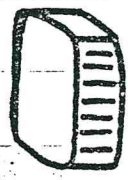
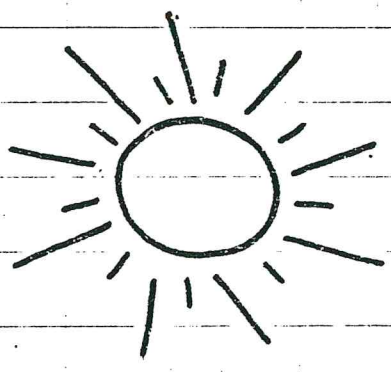

Appartenenza:

- elementi appartenenti e non (7 schede)
ad un insieme dato

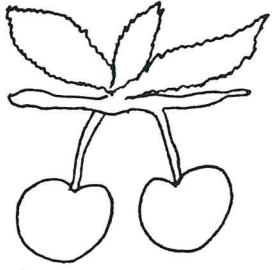
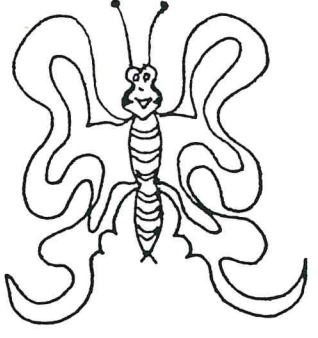
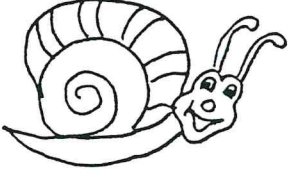
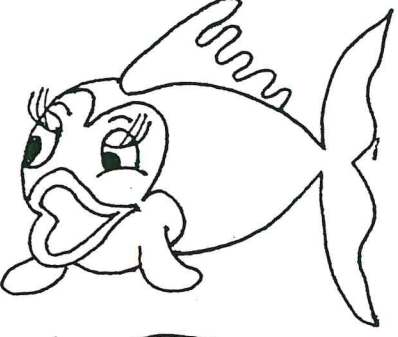
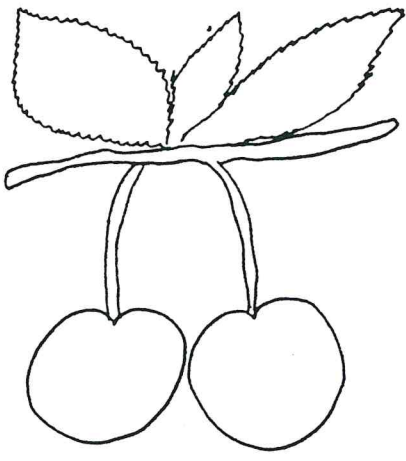
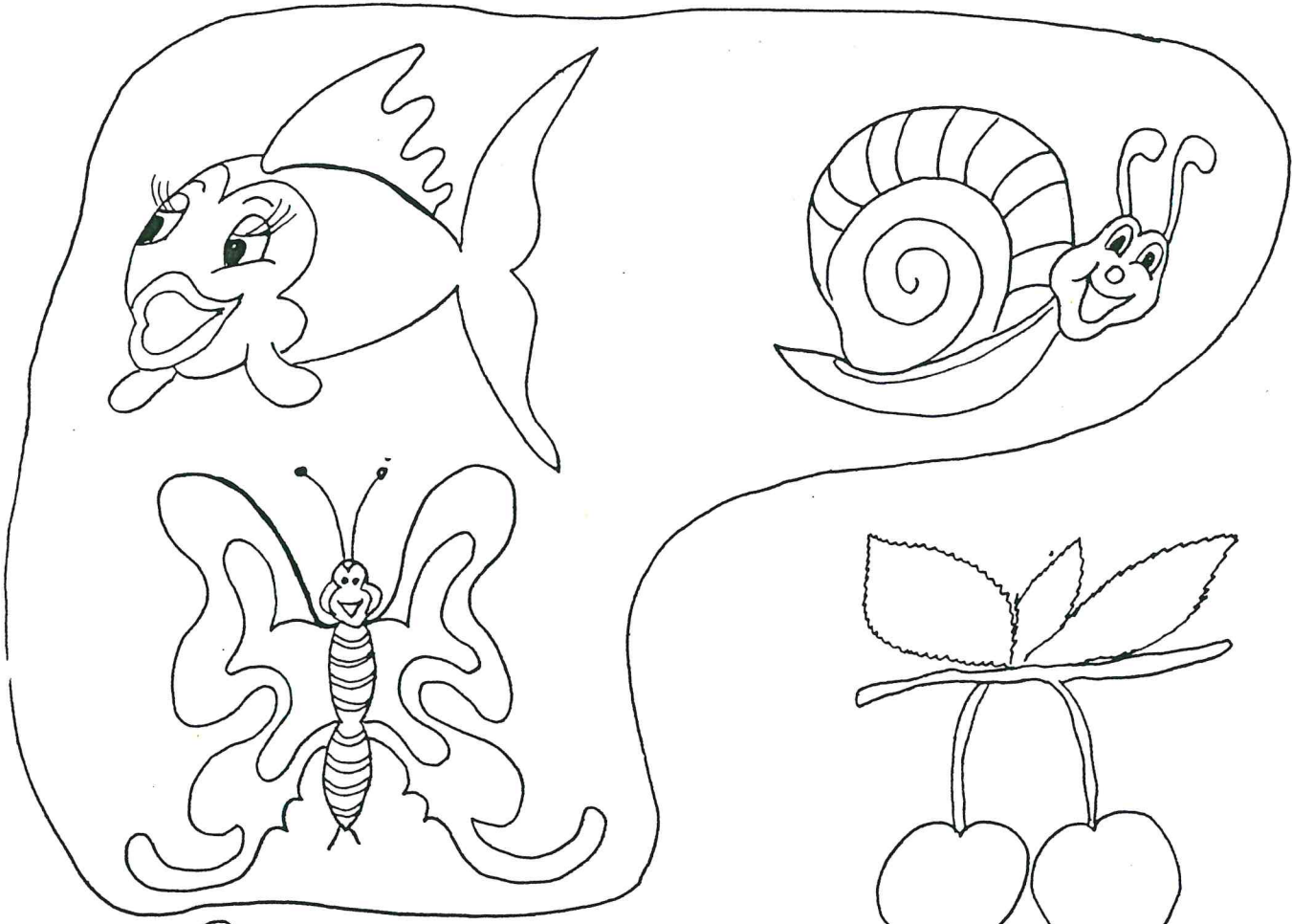

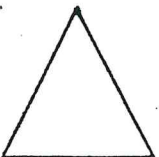
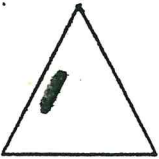
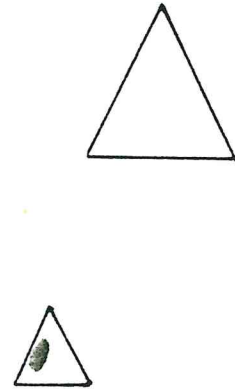
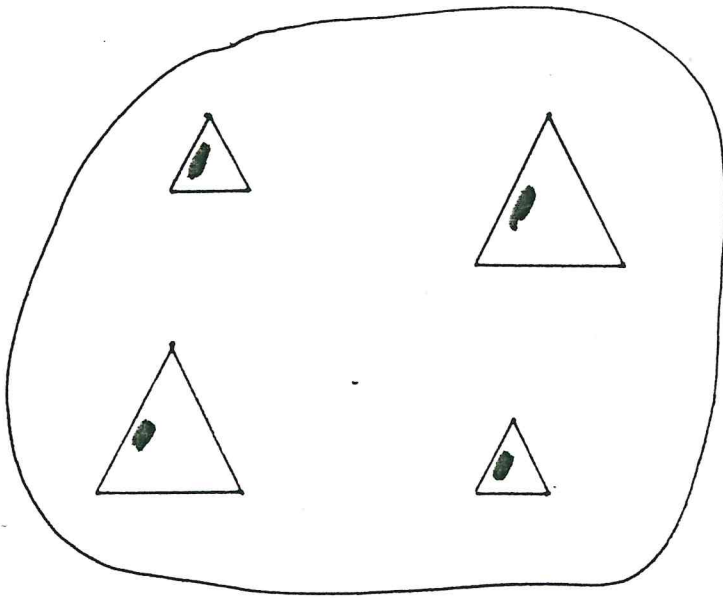

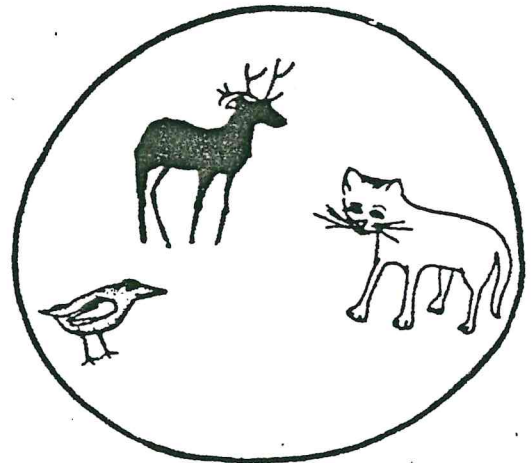
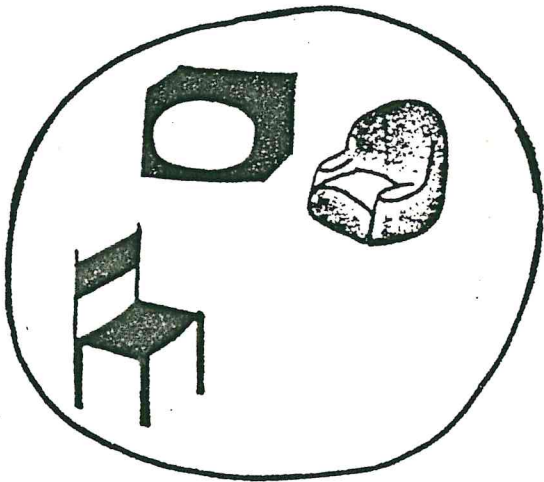
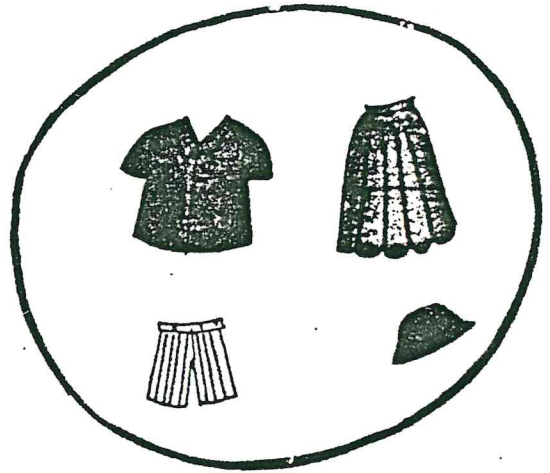
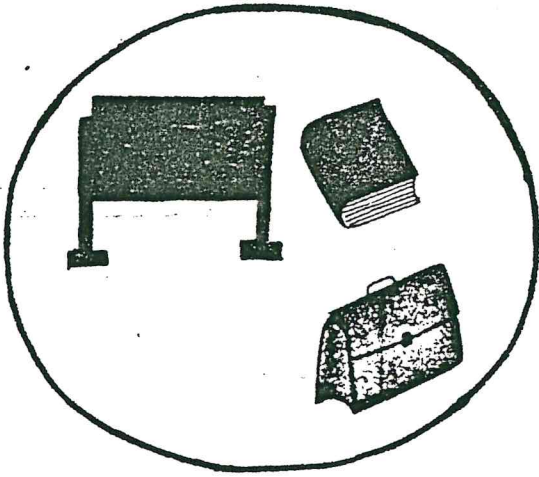
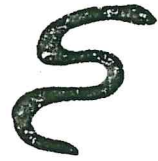
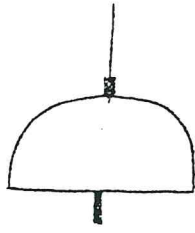

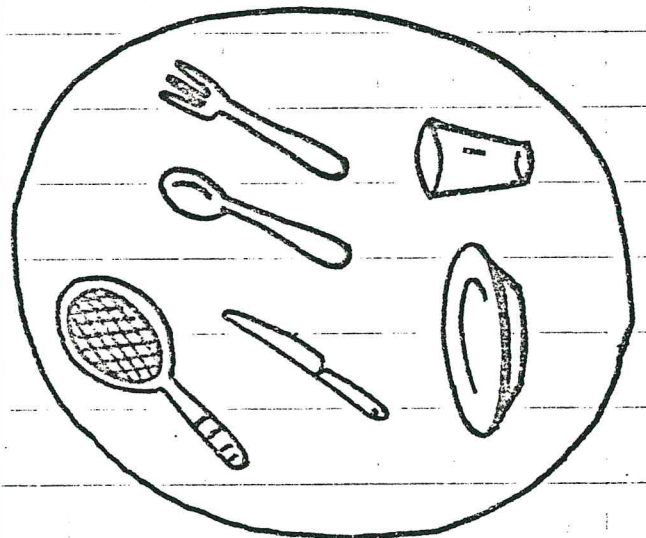
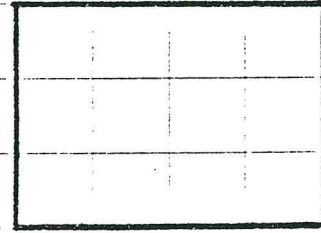
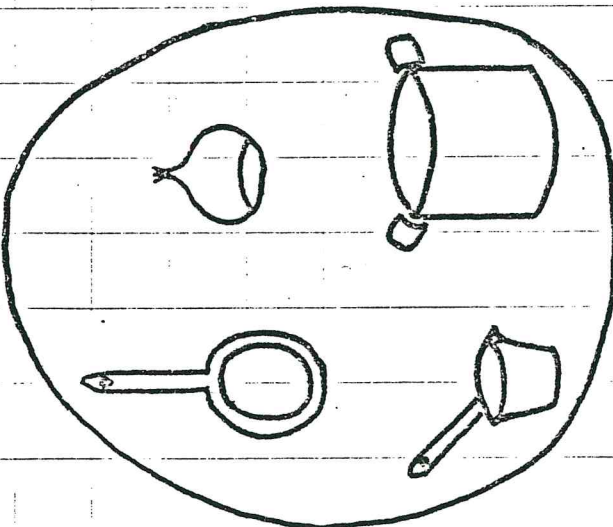
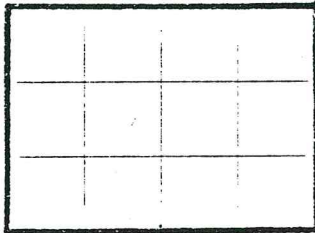
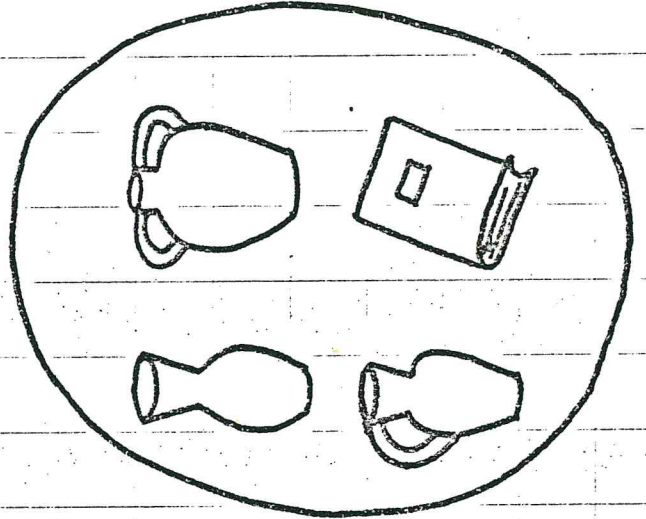
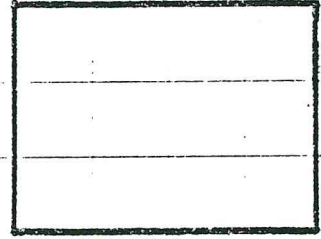
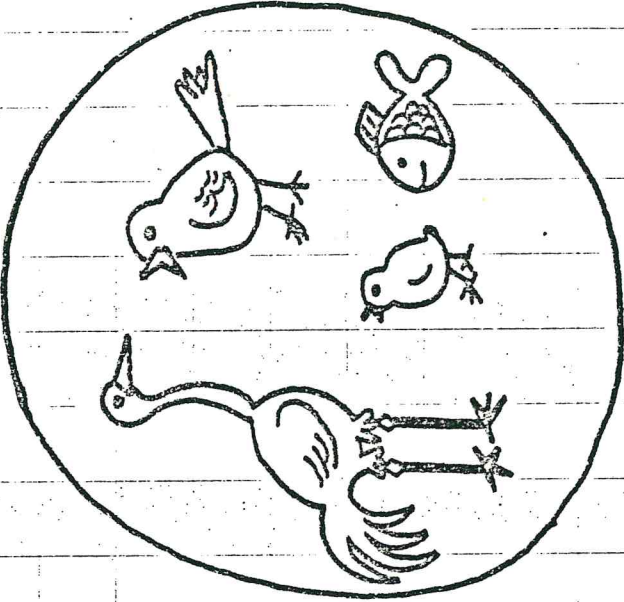
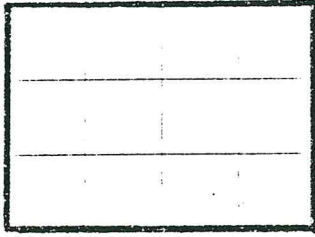

Sottoinsiemi:

- formazione di sottoinsiemi in un insieme dato 3 sch.
- formazione di insiemi e poi ricerca dei sottoinsiemi 4 sch.

TOT. 7 schede

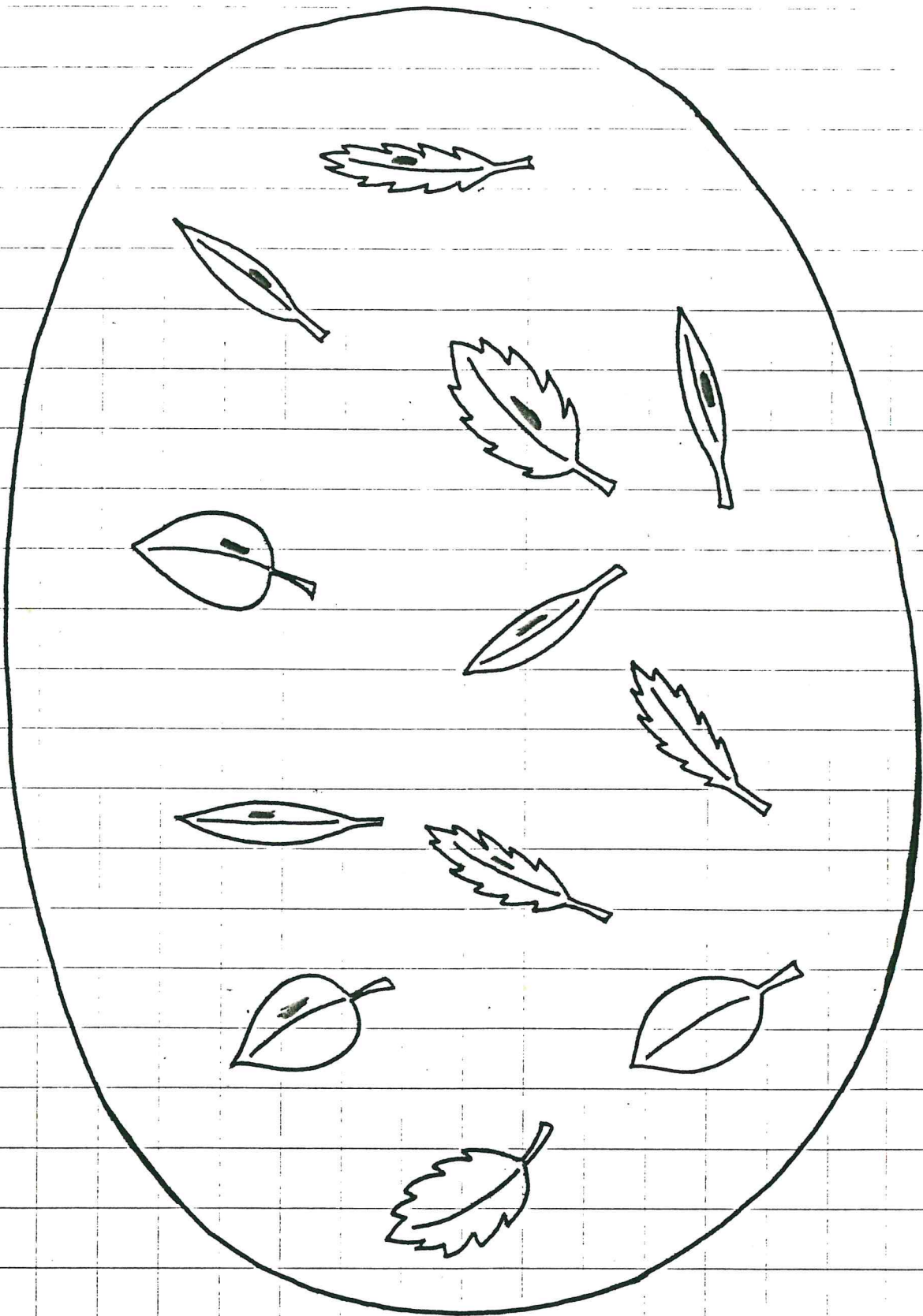

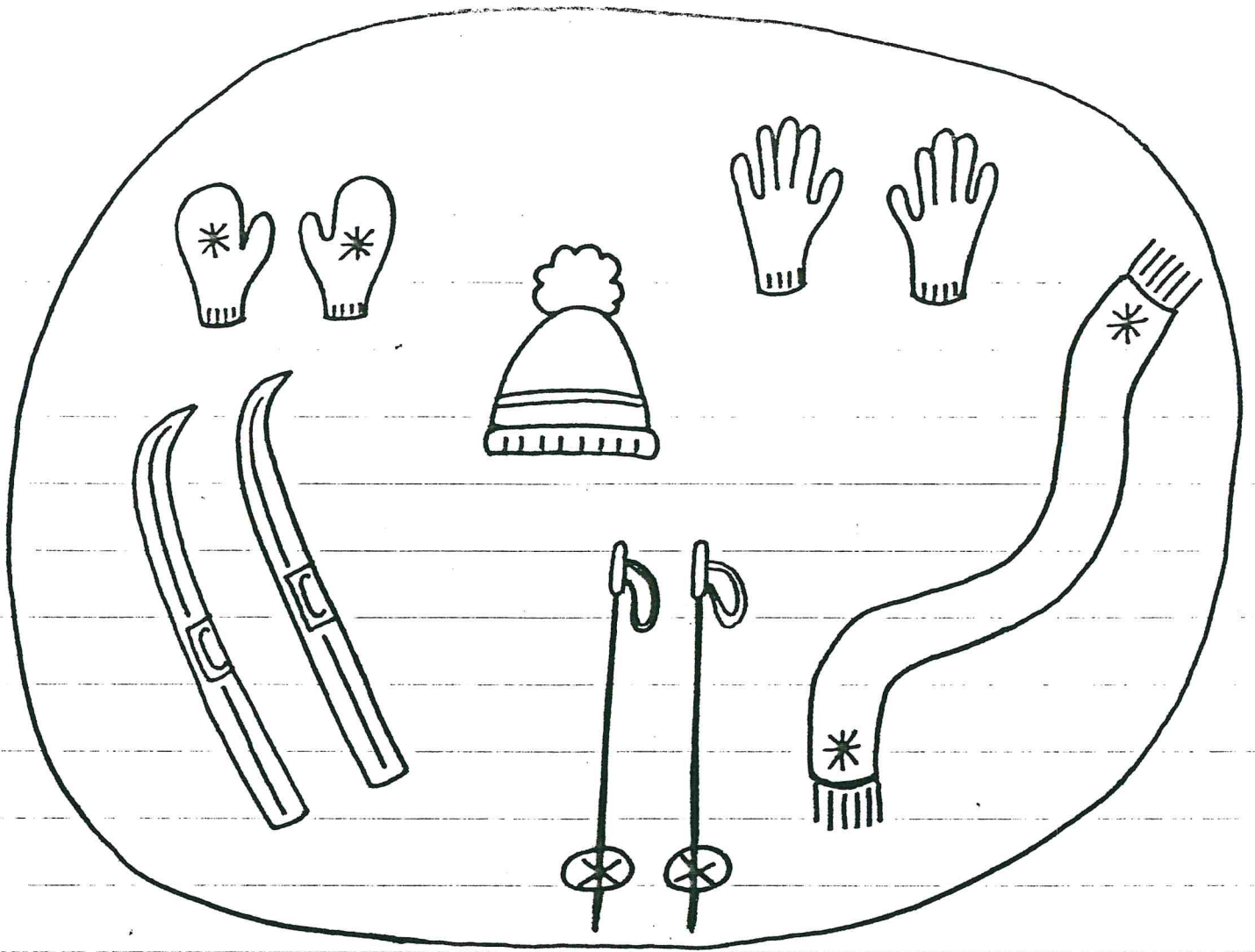

DISEGNA L'INSIEME POI CERCA I SOTTOINSIEMI

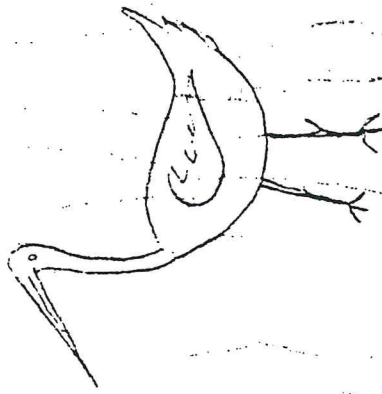
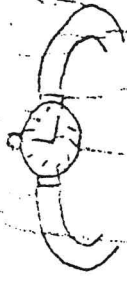
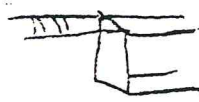

DISEGNA. L'INSIEME POI CERCHIA I SOTTOINSIEMI.

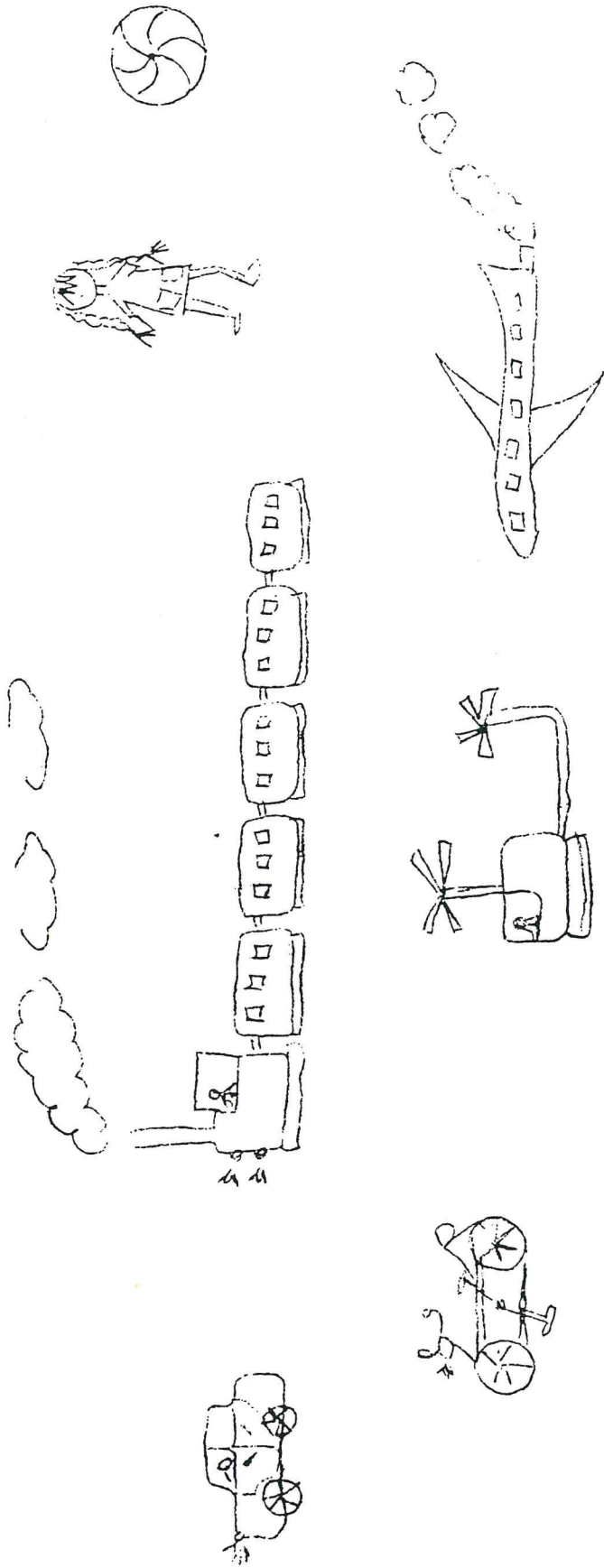

Relazioni:

- relazioni d'ordine (seriazioni) 6 sch.
- relazioni con frecce 6 sch.
- relazioni in tabella 3 sch.

TOT. 15 schede

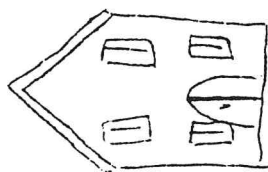
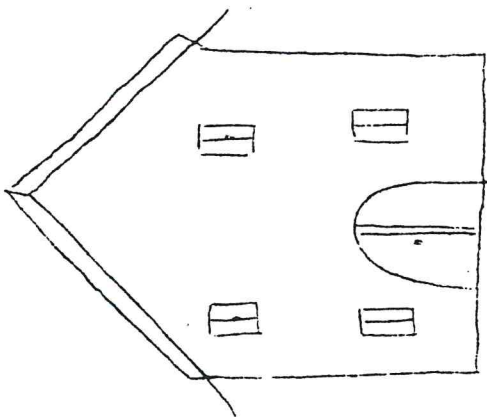
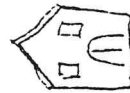
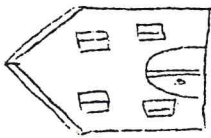
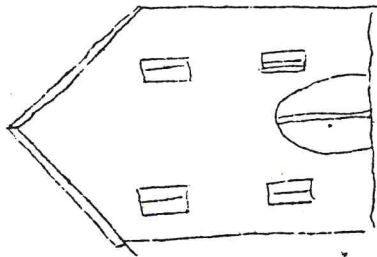
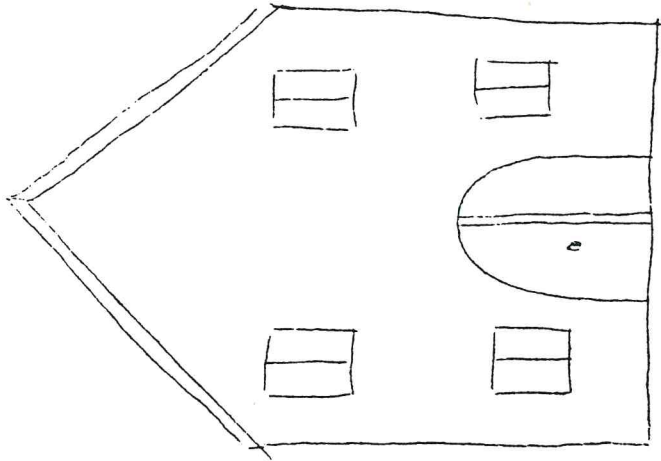

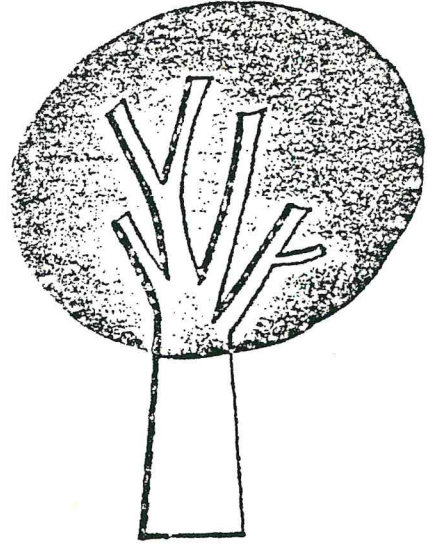
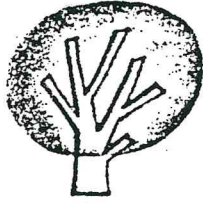
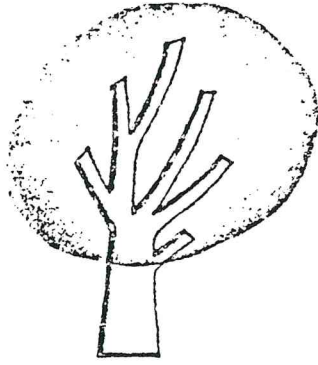
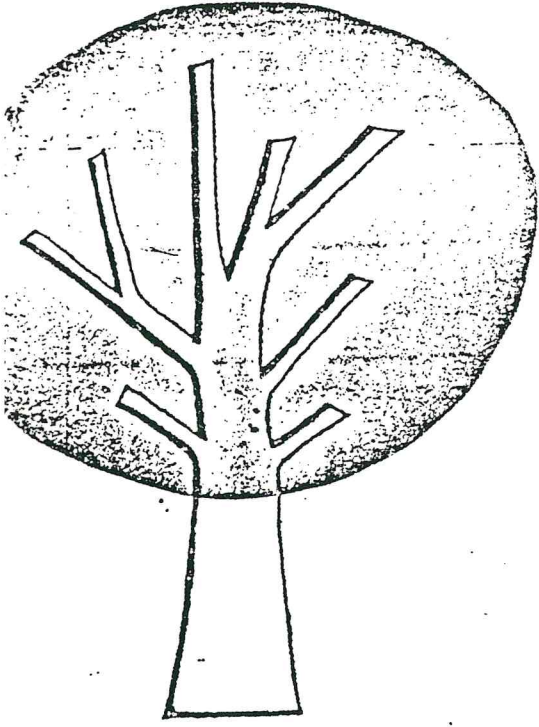

© C.C.D.L.

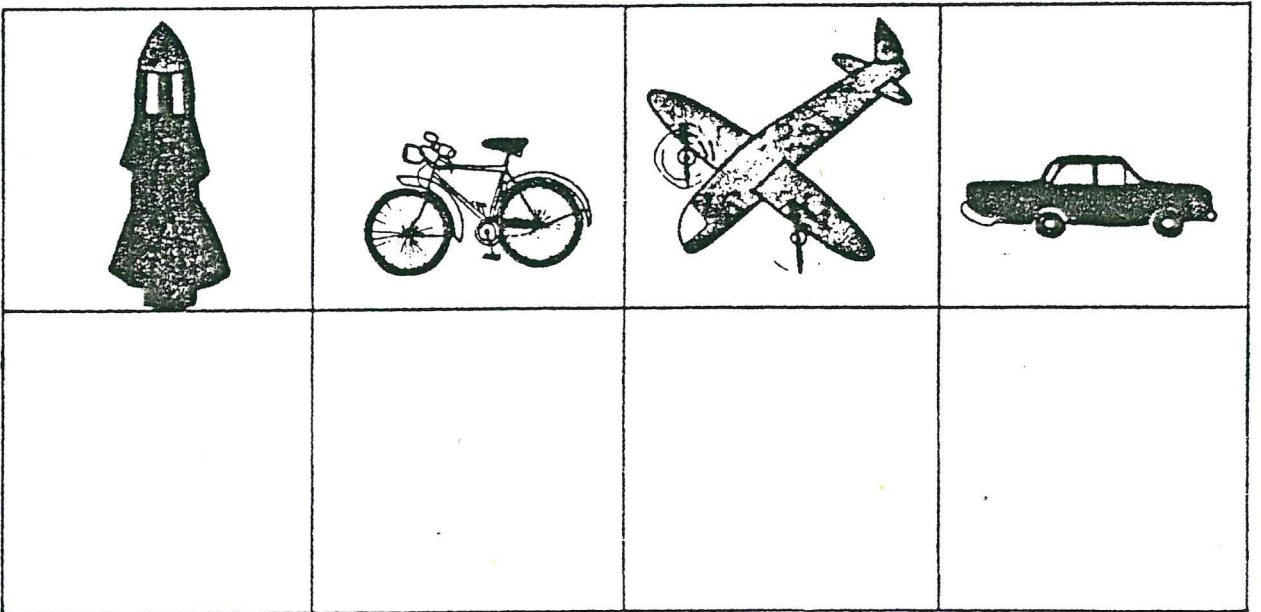
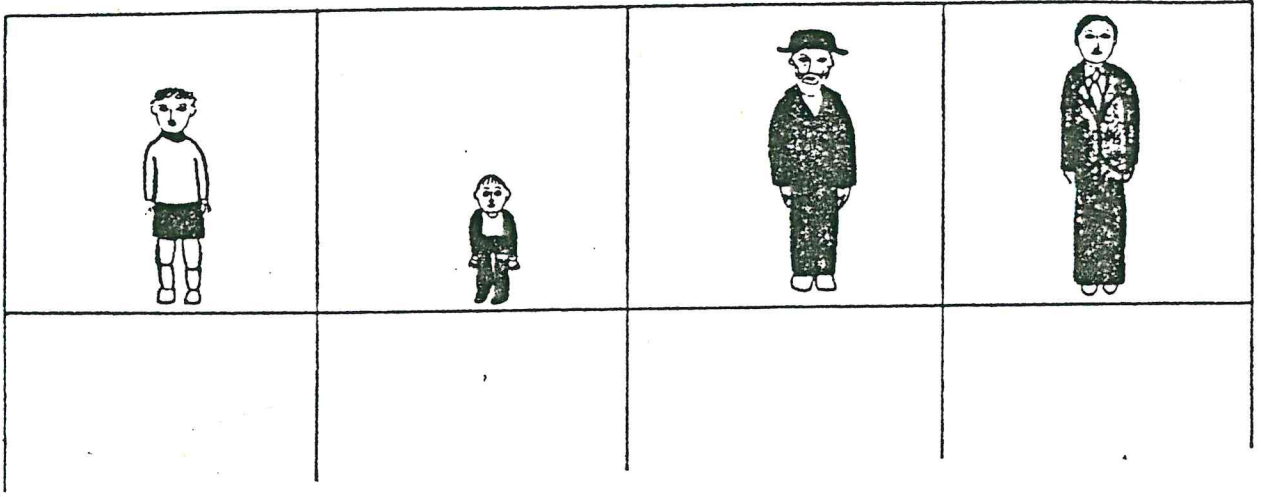

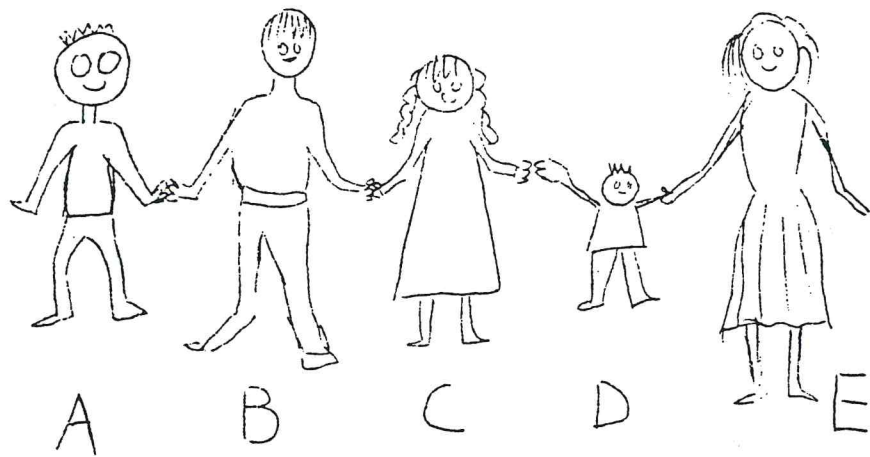

DA LA MANO. A →

A





C



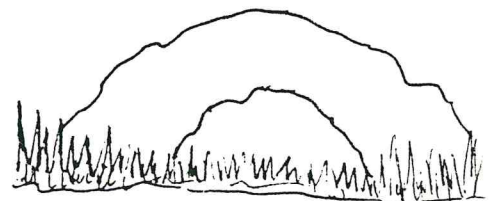
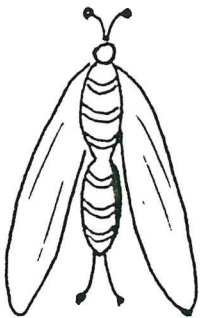
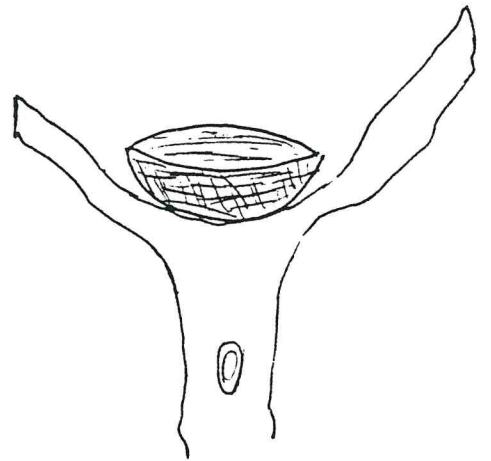
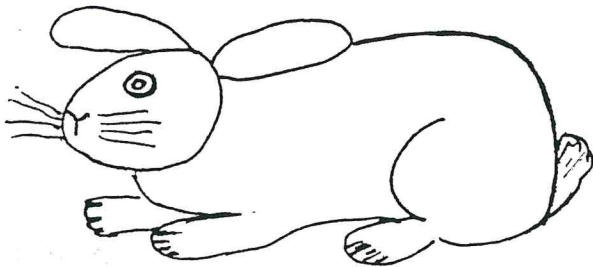
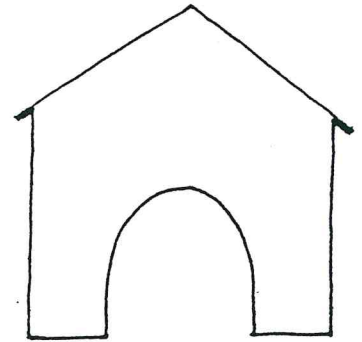
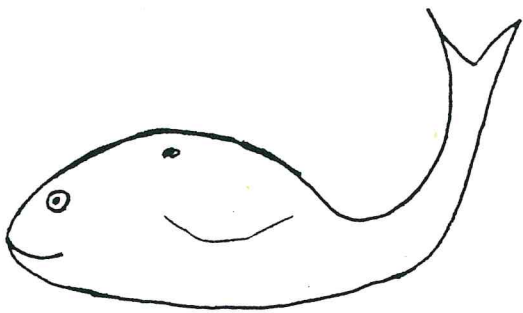
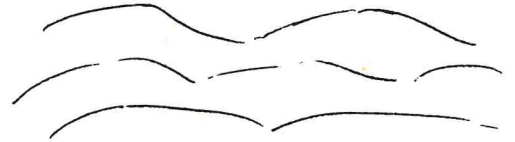
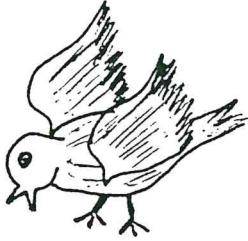
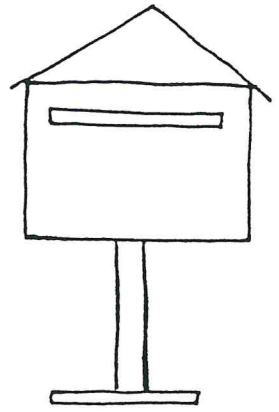
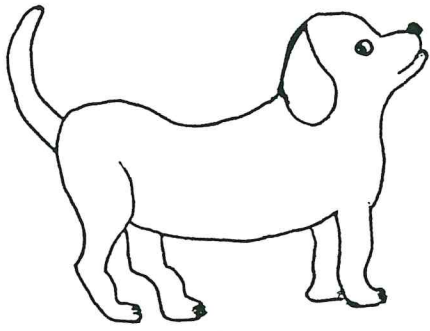



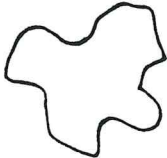

D

E

B



3000000

Corrispondenza fra insiemi :

- corrispondenza biunivoca 6 sch.

- corrispondenza univoca 4 sch.

TOT. 10 schede

OGNI NIDO?

SUA

?

OGNI RONDINE ?

SUA

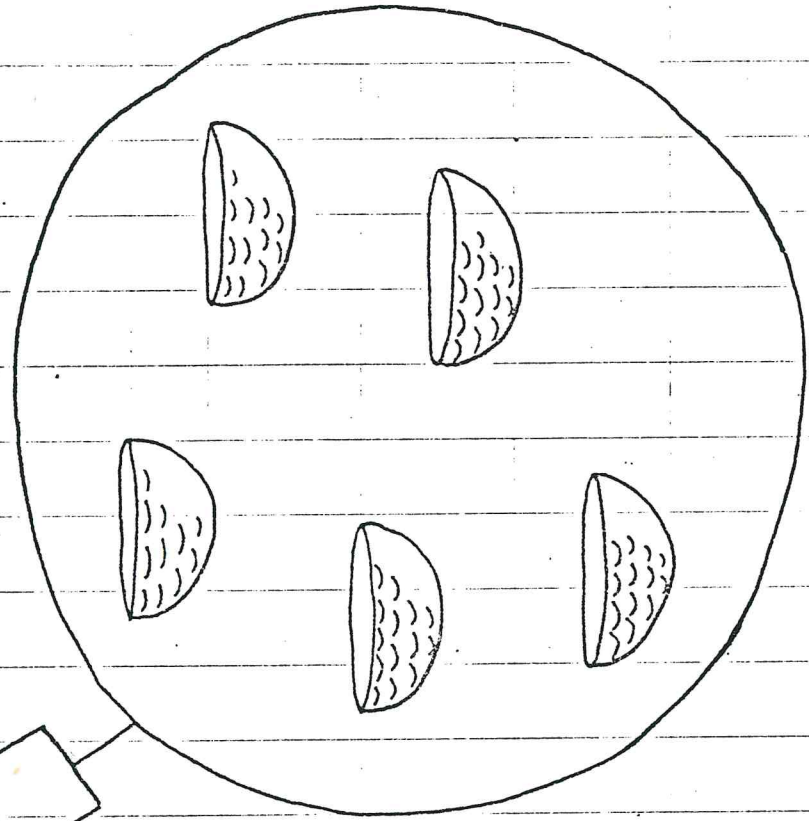
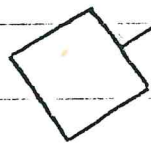

OGNI RONDINE

HA IL

OGNI NIDO

HA LA

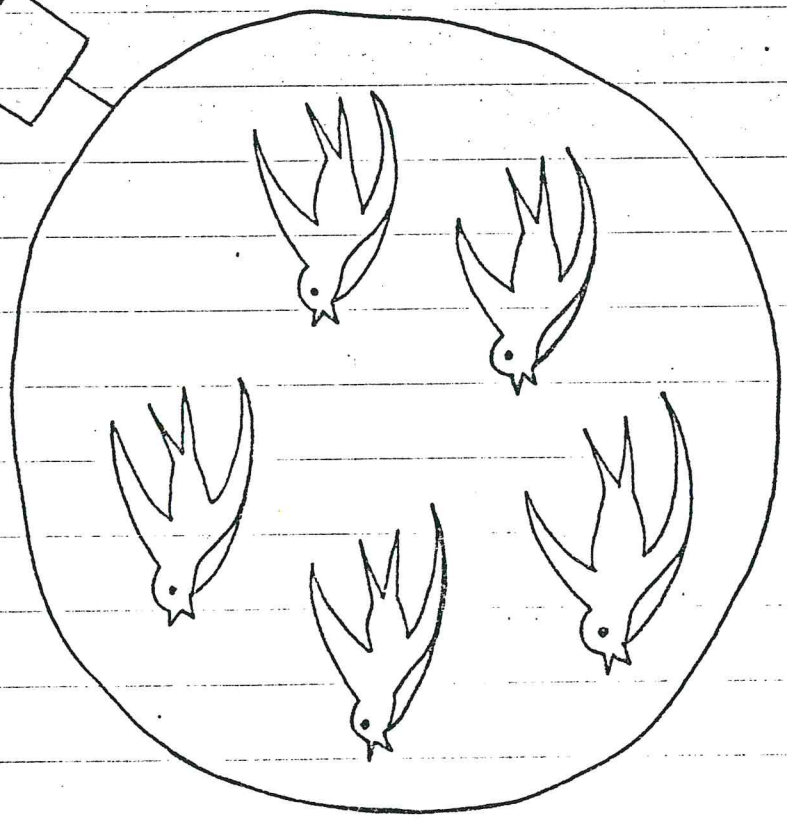
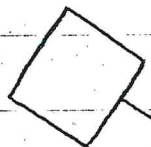

OGNI BARCA HA LA SUA VELA ?

OGNI VELA HA LA SUA BARCA ?

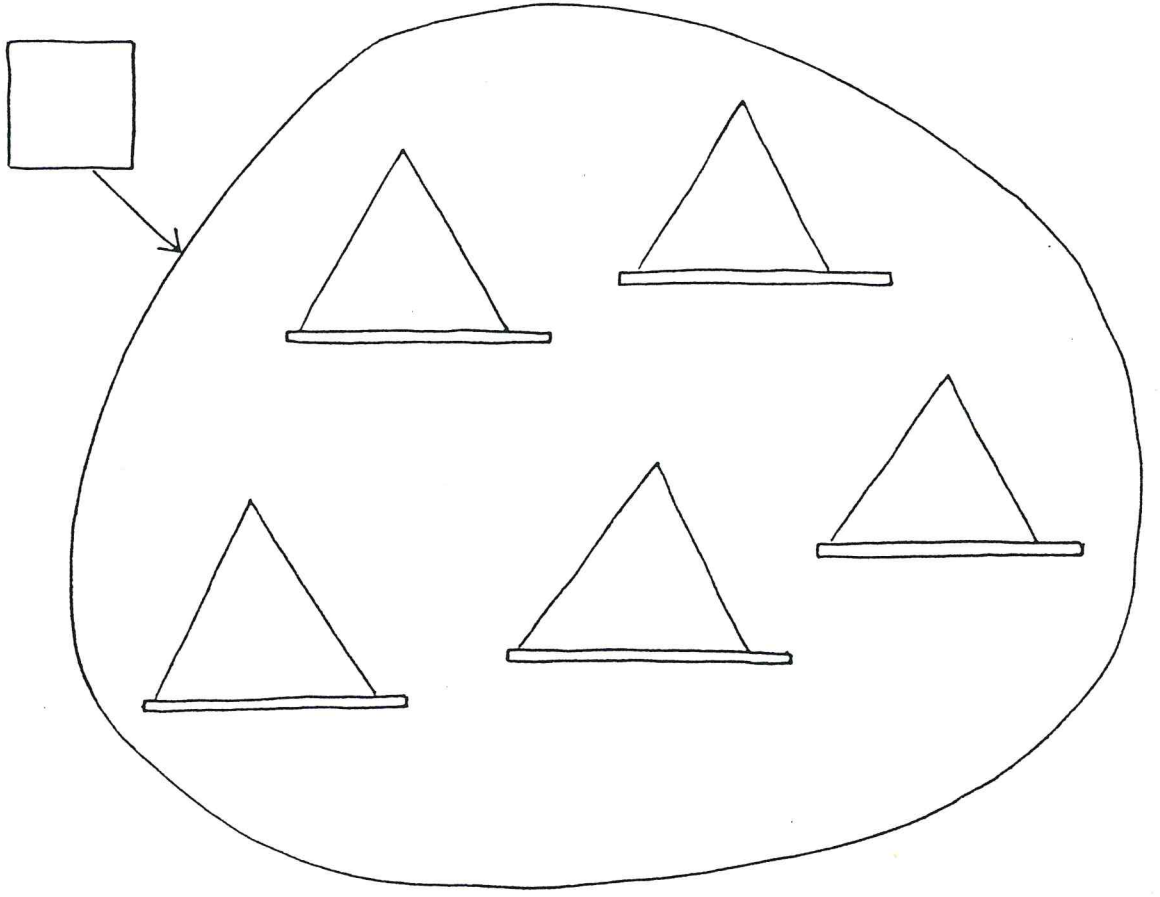
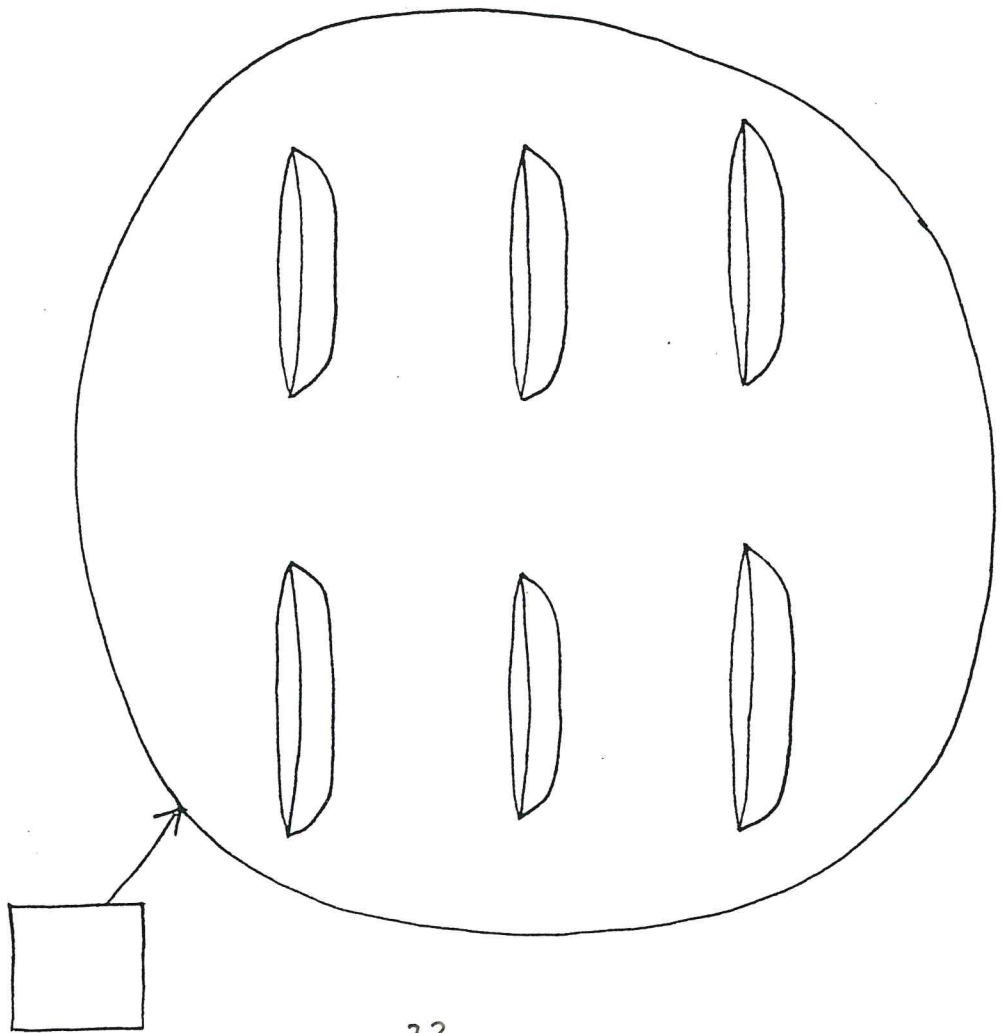

NON C'È UNA PALLA PER OGNI BAMBINO

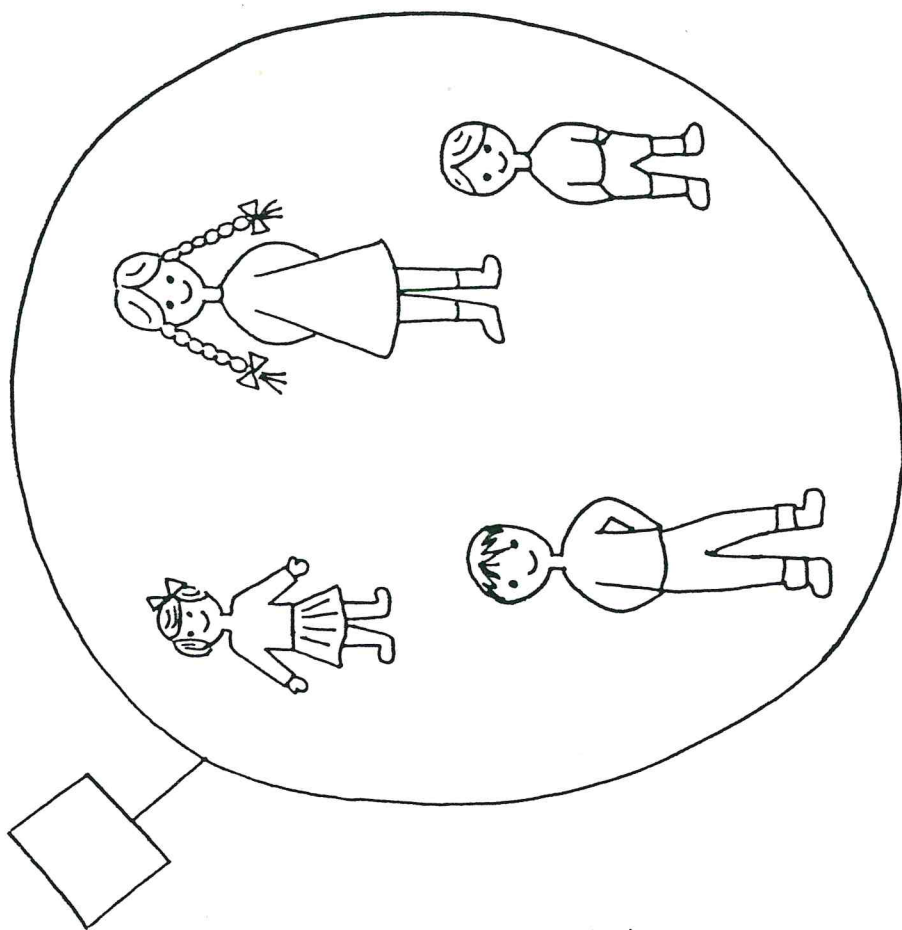
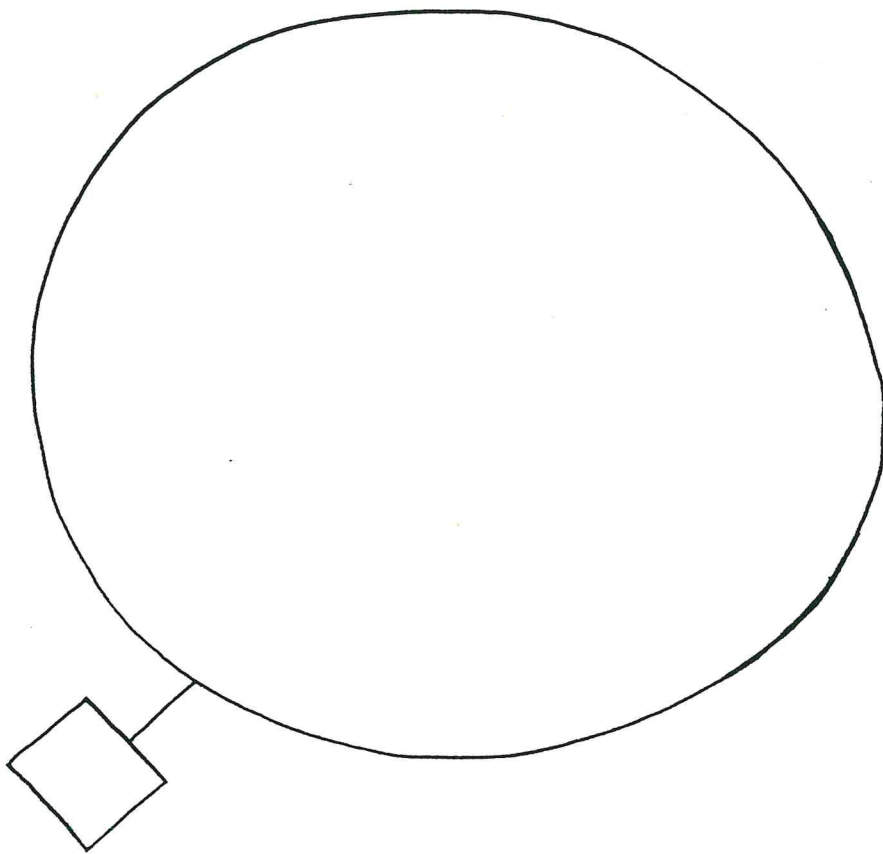

Potenza degli insiemi :

- potenza degli insiemi con simboli individuali (quadrato) 2 sch.
- insiemi equipotenti e non 1 sch.
- insiemi più o meno potenti di un insieme dato 1 sch.
- $N \square A = N \square B$; $N \square A \neq N \square B$ 1 sch.

TOT. 5 schede

PER OGNI ELEMENTO DELL'INSIEME DISEGNA UN QUADRATINO

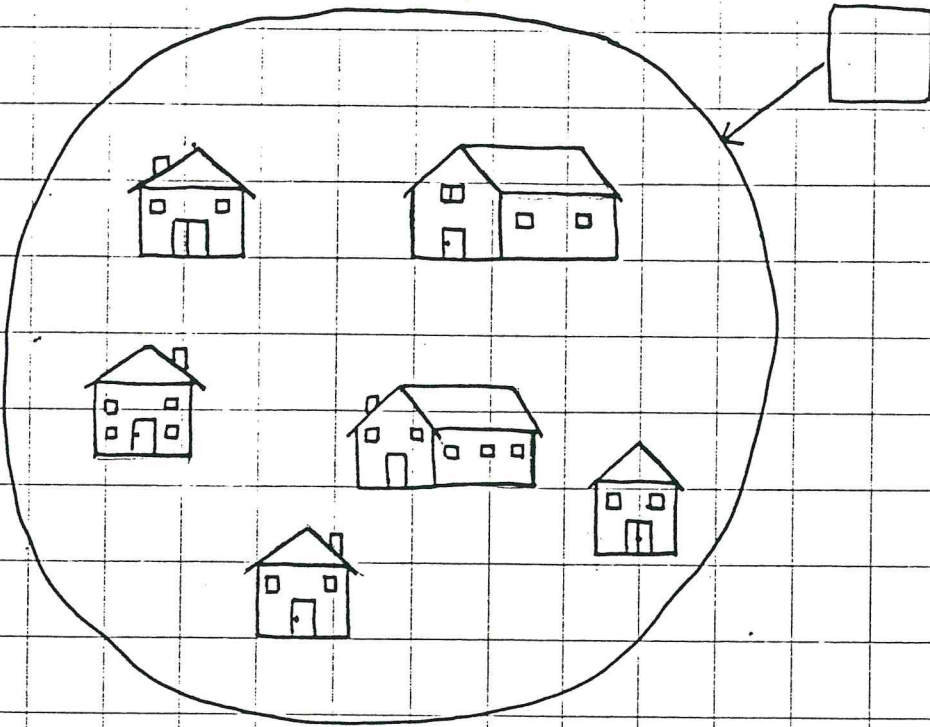

PER OGNI ELEMENTO DELL'INSIEME DISEGNA UN QUADRATINO

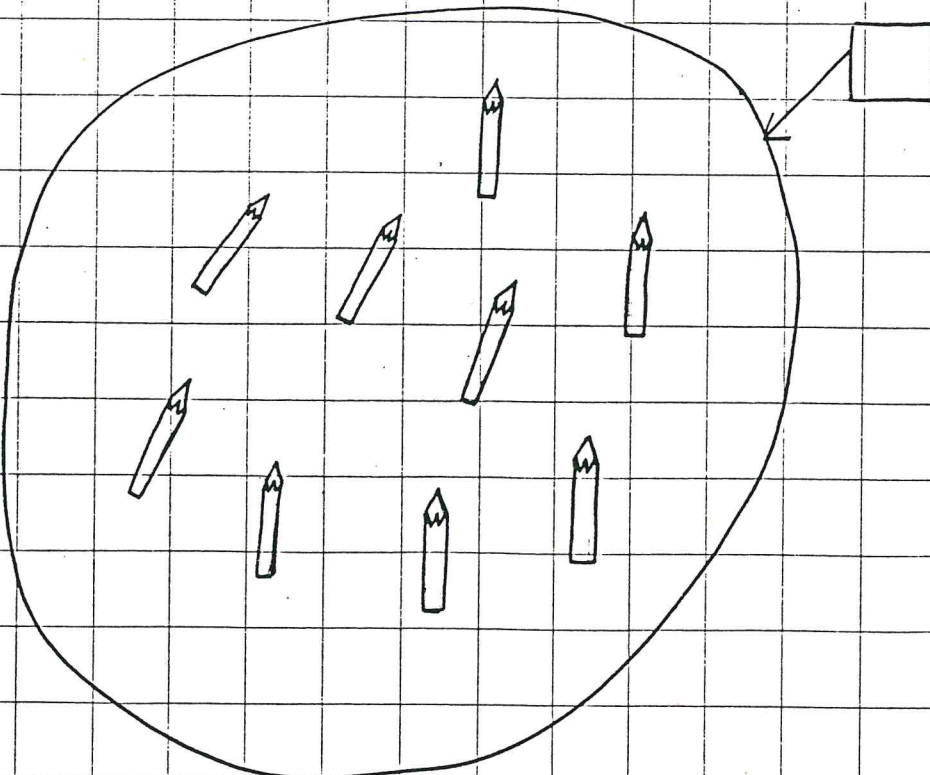

PER OGNI ELEMENTO DELL'INSIEME DISEGNA UN QUADRATINO.

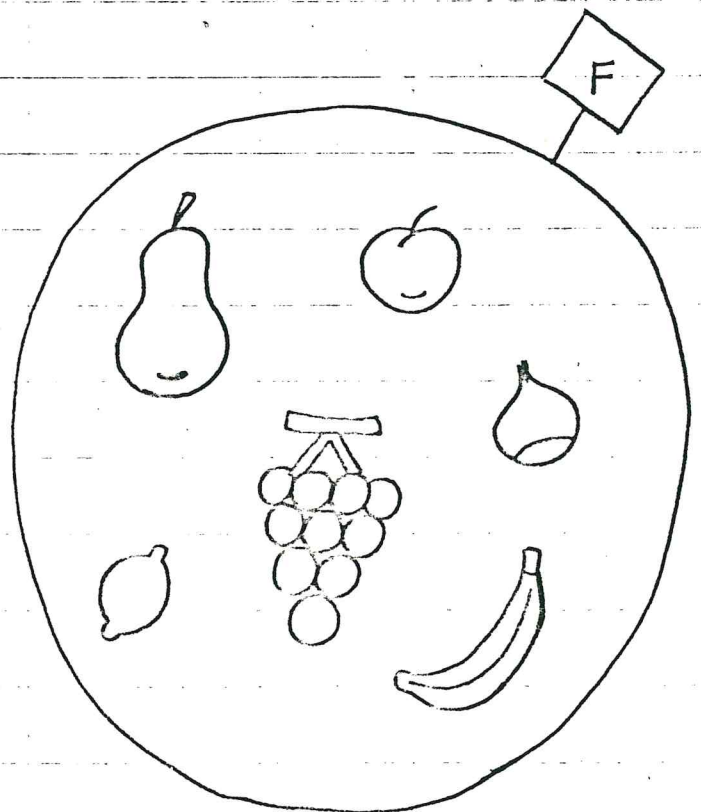
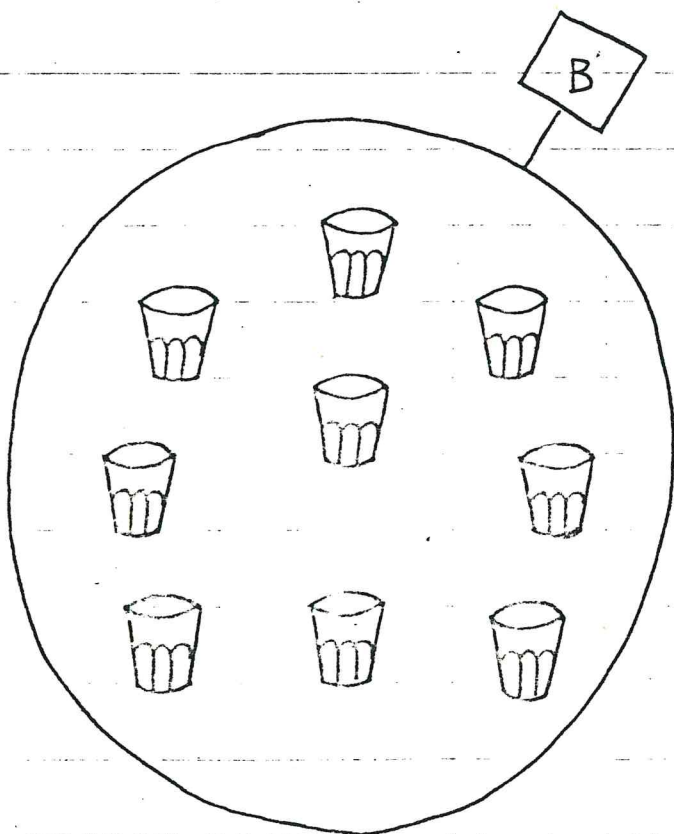
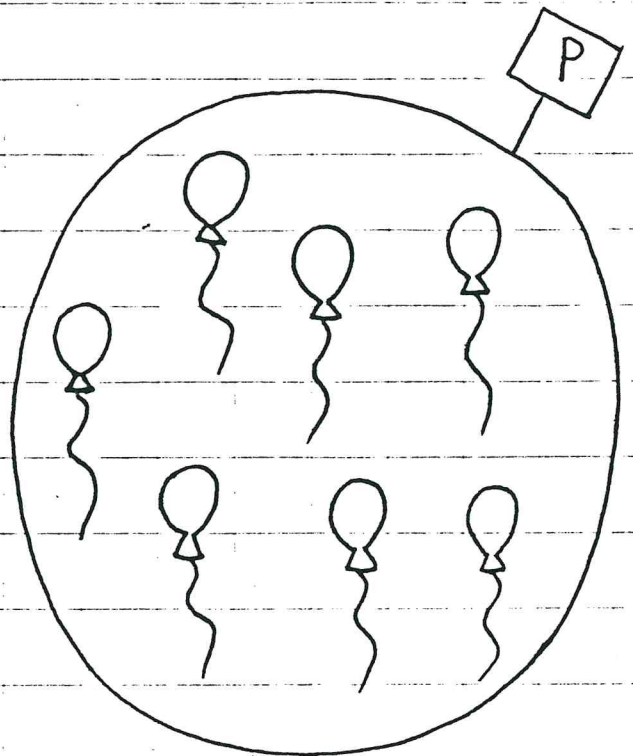
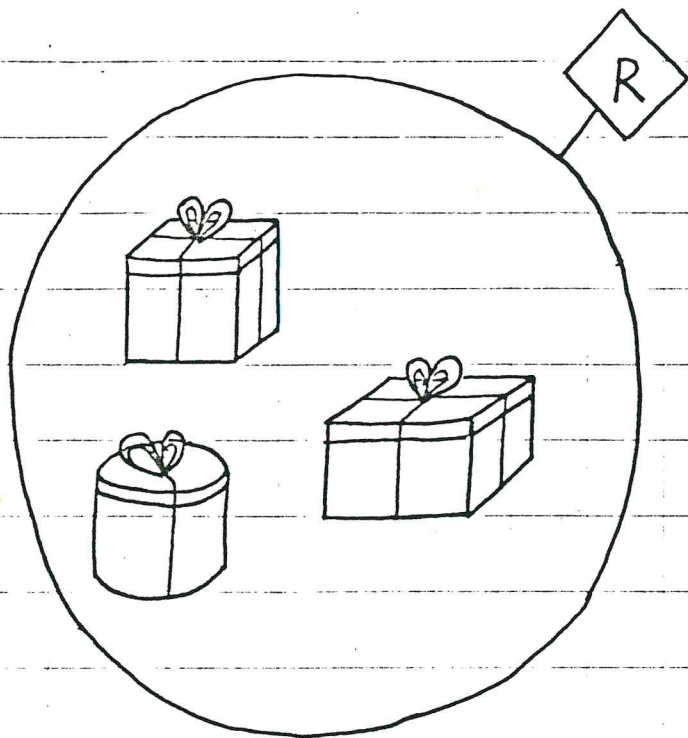

DISEGNA UN INSIEME DI FIORI EQUIPOTENTE A T

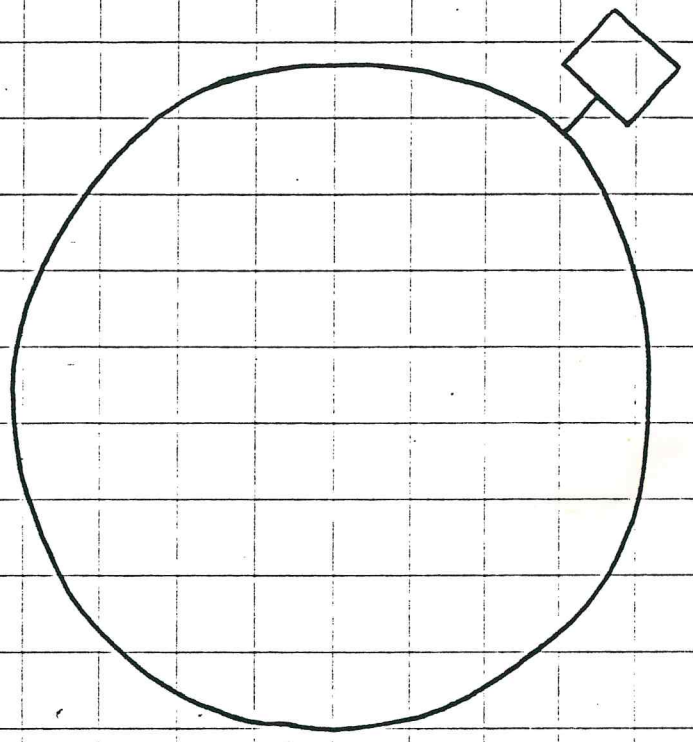
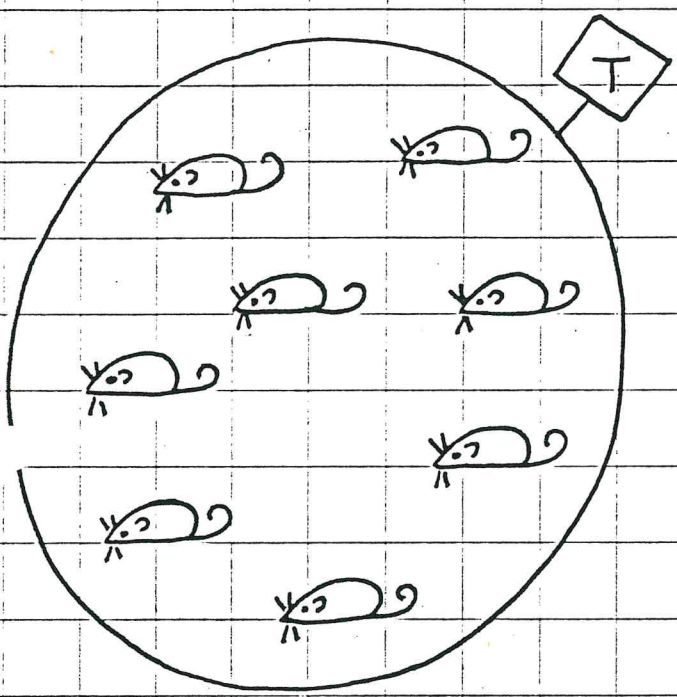

DISEGNA UN INSIEME DI PALLE NON EQUIPOTENTE A B

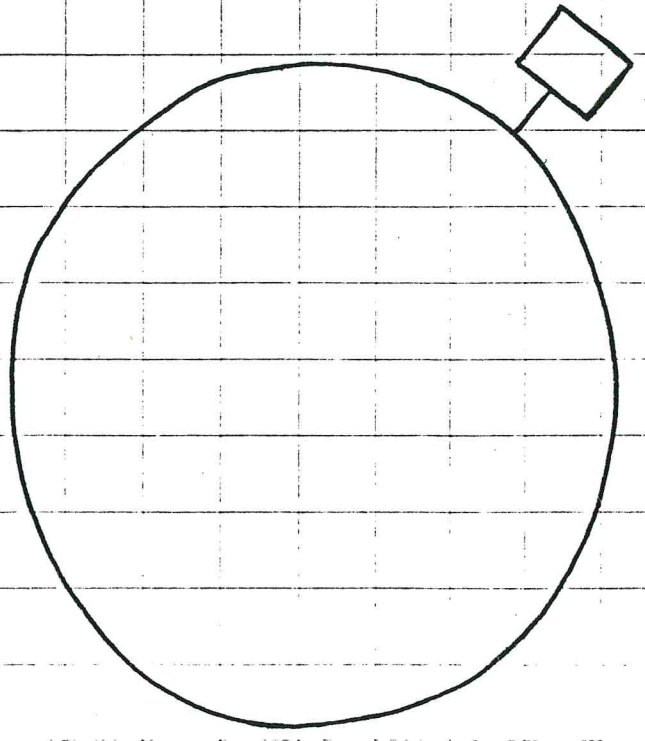
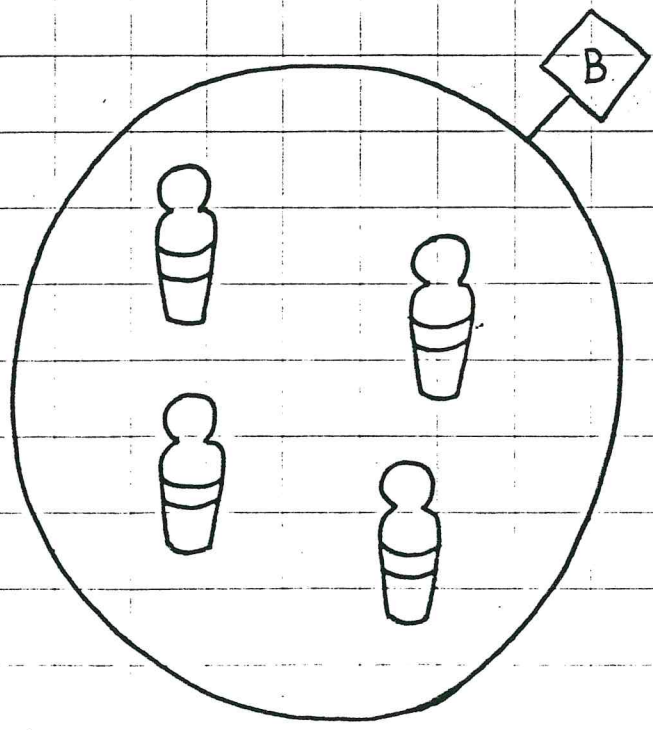

DISEGNA UN INSIEME DI FARFALLE PIÙ POTENTE

Di Fi

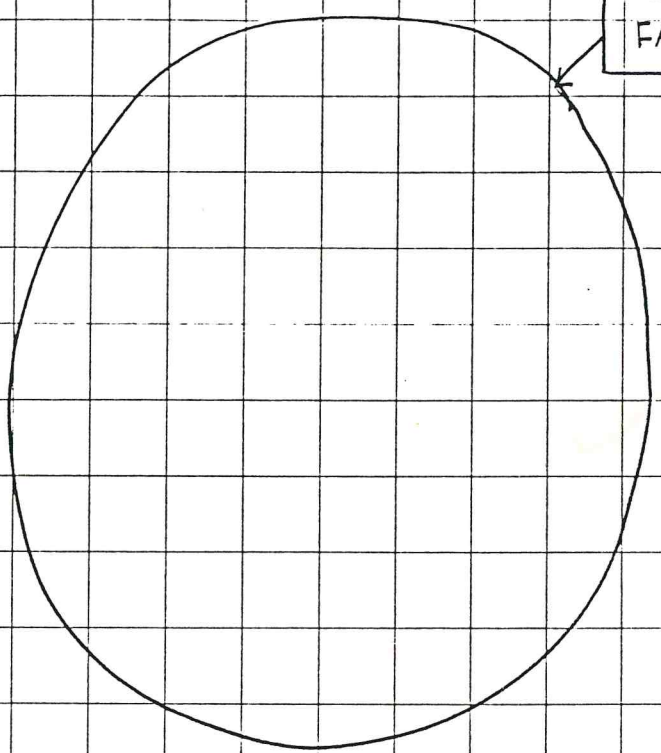
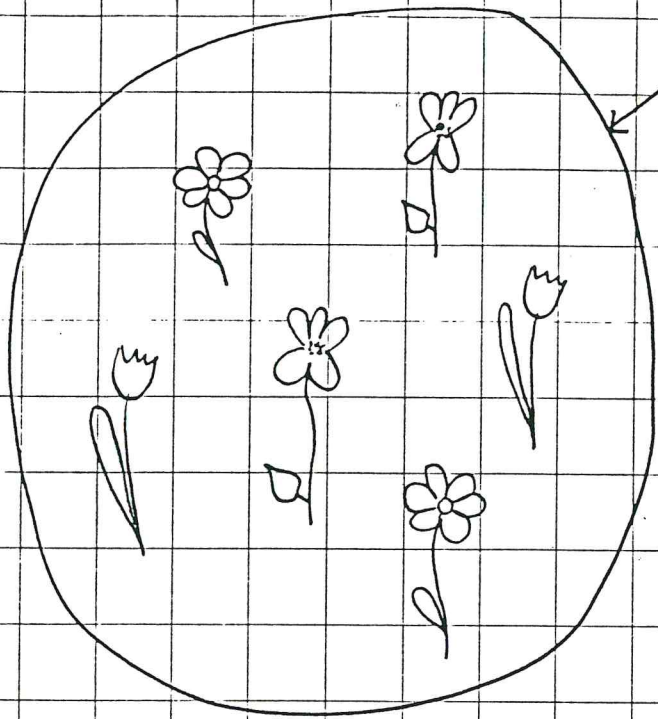

DISEGNA UN INSIEME DI ALBERI MENO POTENTE

Di Fi

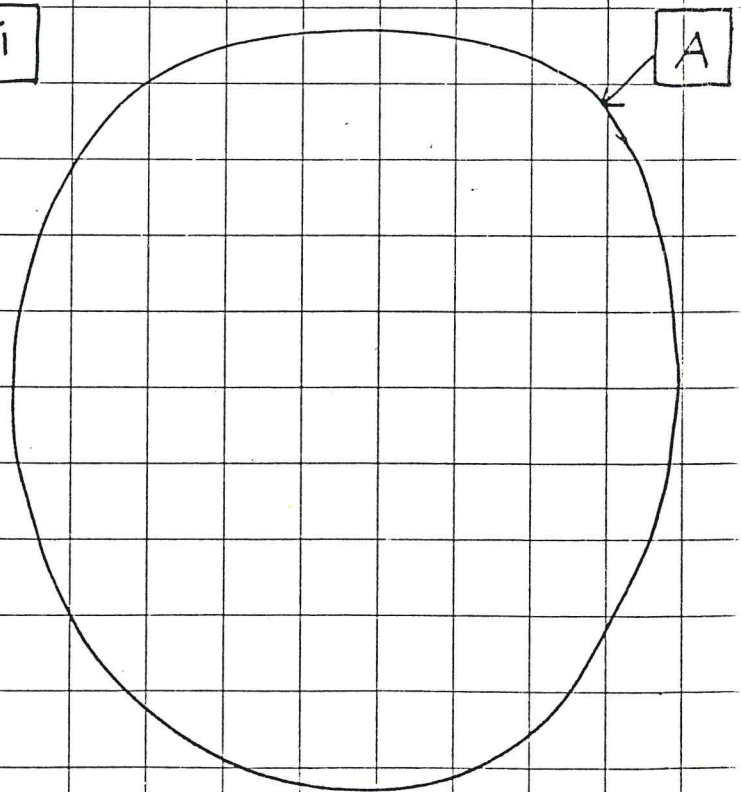
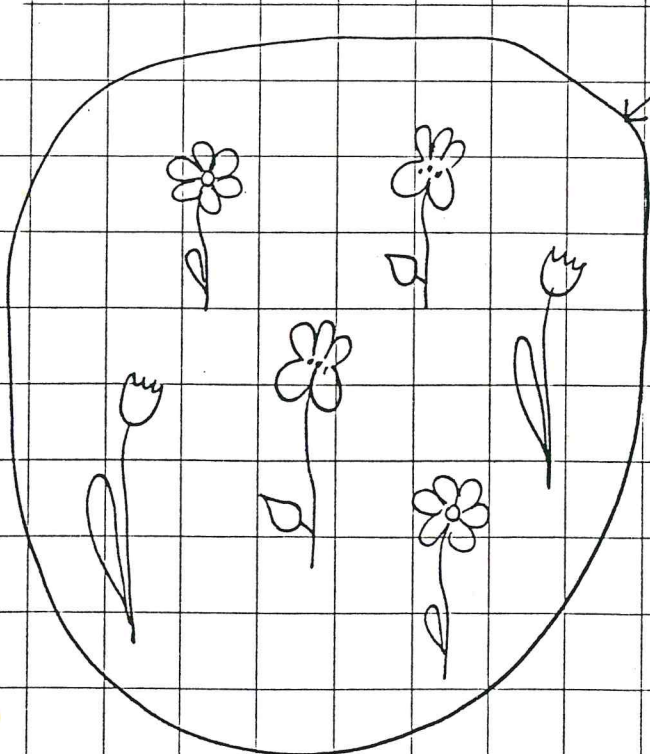

Attività sui numeri da 0 a 20 :

- numero degli elementi di un insieme (4 sch.)
- elementi corrispondenti al numero (5 sch.)
- corrispondenza fra insiemi, numeri e parole (1 sch.)
- linee dei numeri da 0 a 9 (6 sch.)
- insiemi da incollare nelle caselle corrispondenti (7 sch.)
- scopri la figura nascosta (da 0 a 9) (3 sch.)
- linee dei numeri con i passi da 0 a 9 (5 sch.)
- 1 elemento in più 1 elemento in meno di un insieme dato (da 0 a 9) (2 sch.)
- numero degli elementi di un insieme da 10 a 20 (2 sch.)
- lettura e scrittura dei numeri da 0 a 20 (2 sch.)
- linee dei numeri da 0 a 20 (4 sch.)
- scopri la figura nascosta (da 0 a 20) (1 sch.)
- raggruppamenti (2 sch.)
- maggiore e minore fra insiemi e numeri (4 sch.)

TOT. 48 schede

NEL CARTELLINO SCRIVI IL NUMERO DEGLI ELEMENTI CHE SONO DENTRO ALL'INSIEME

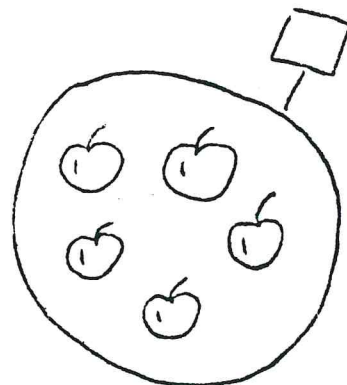
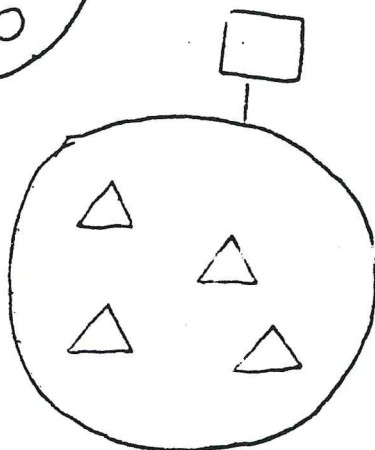
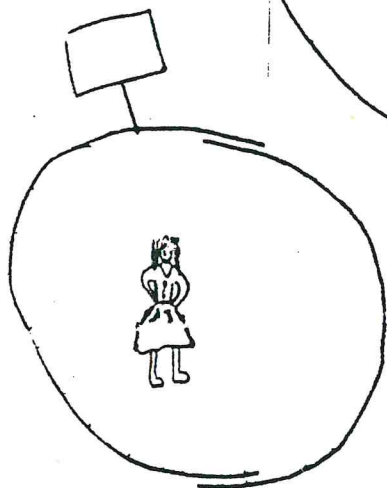
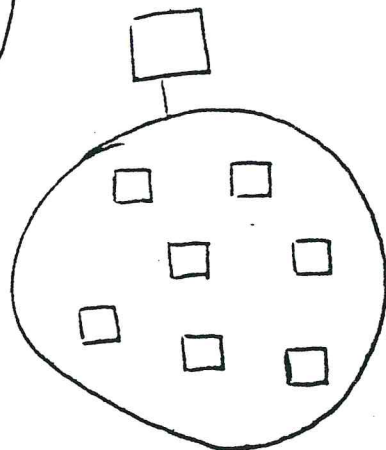
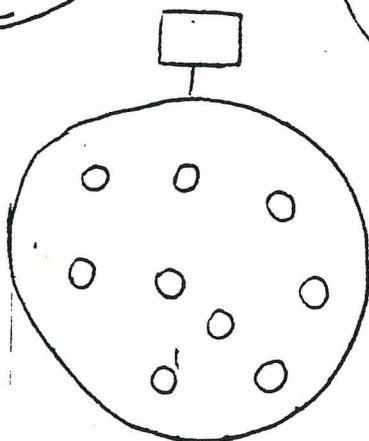
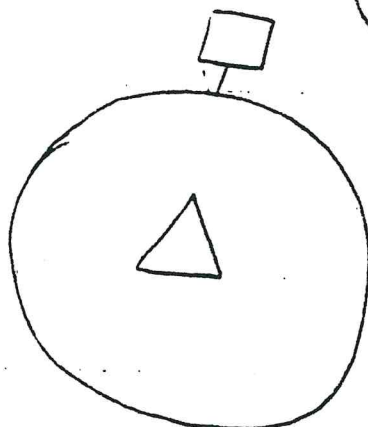
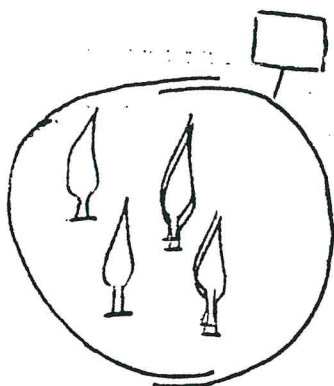
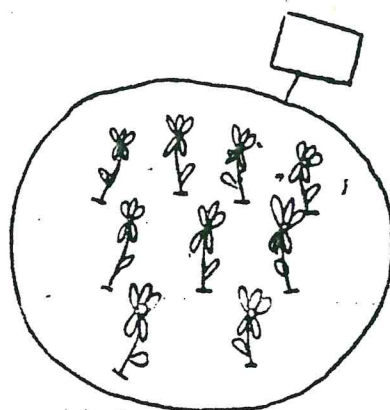
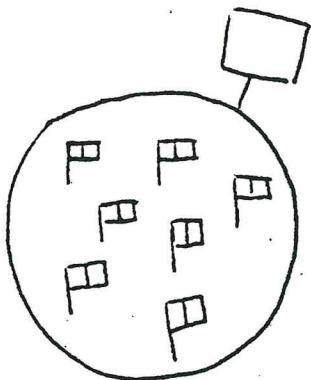
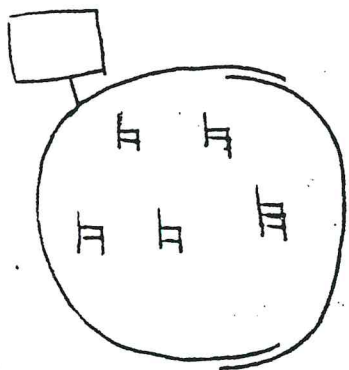

NEL CARTELLINO SCRIVI IL NUMERO DEGLI ELEMENTI CHE SONO DENTRO ALL' INSIEME

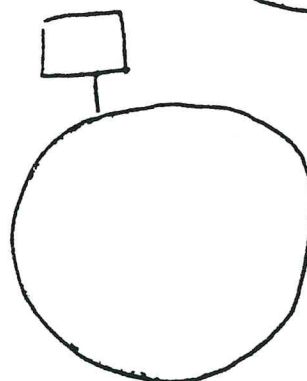
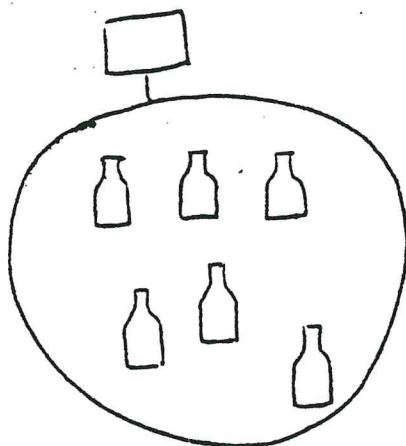
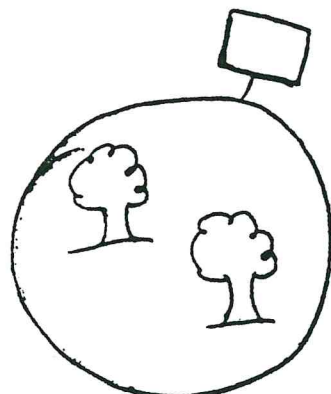
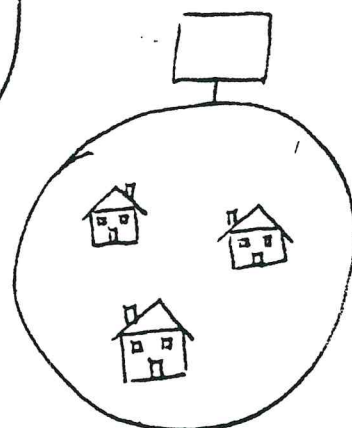
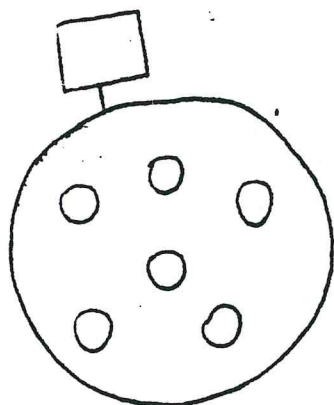
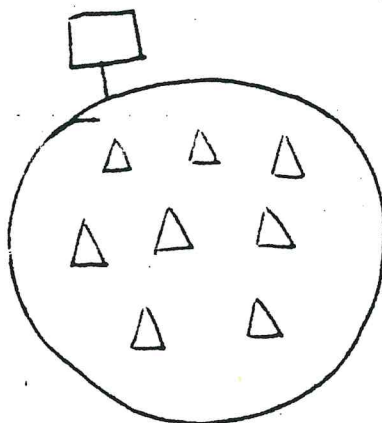
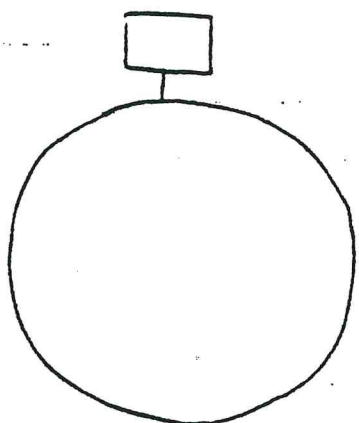
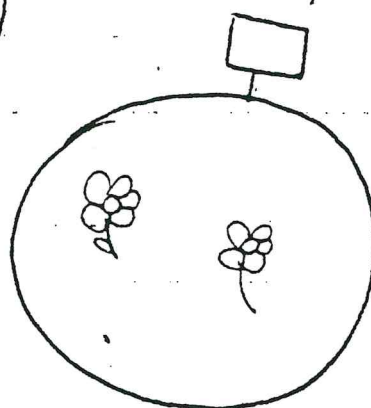
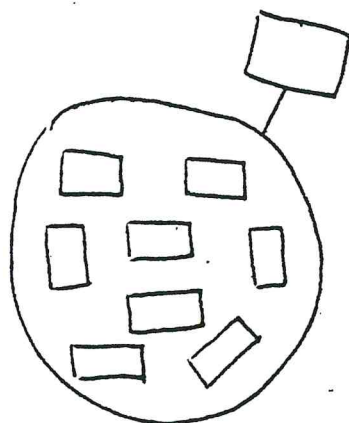
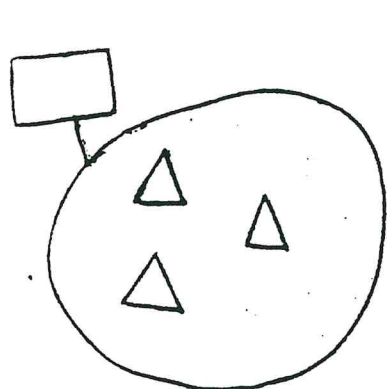

DISEGNA NELL'INSIEME TANTI ELEMENTI QUANTI
NE INDICA IL NUMERO SCRITTO NEL CARTELLINO

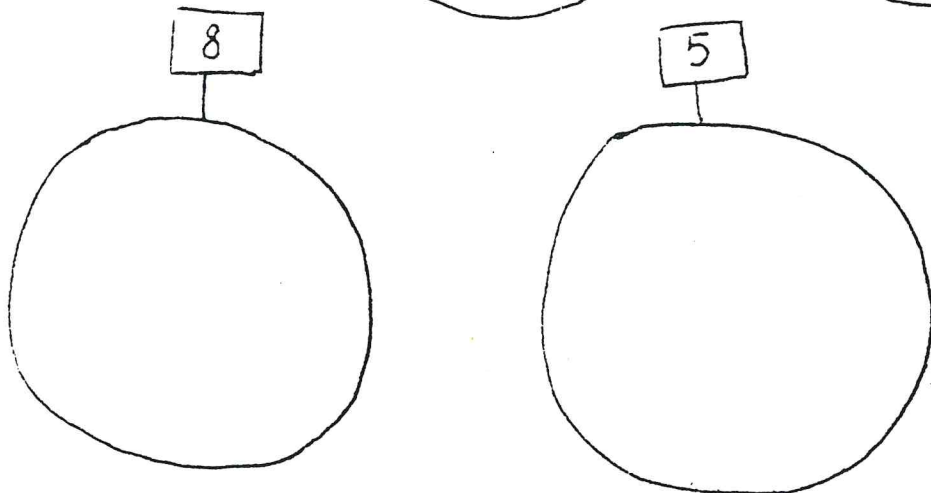
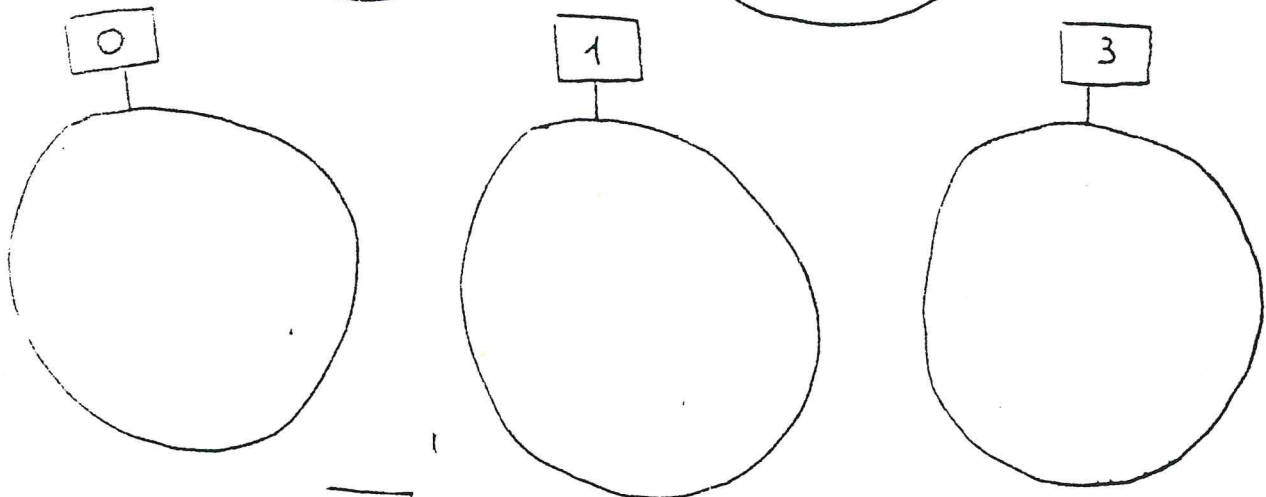
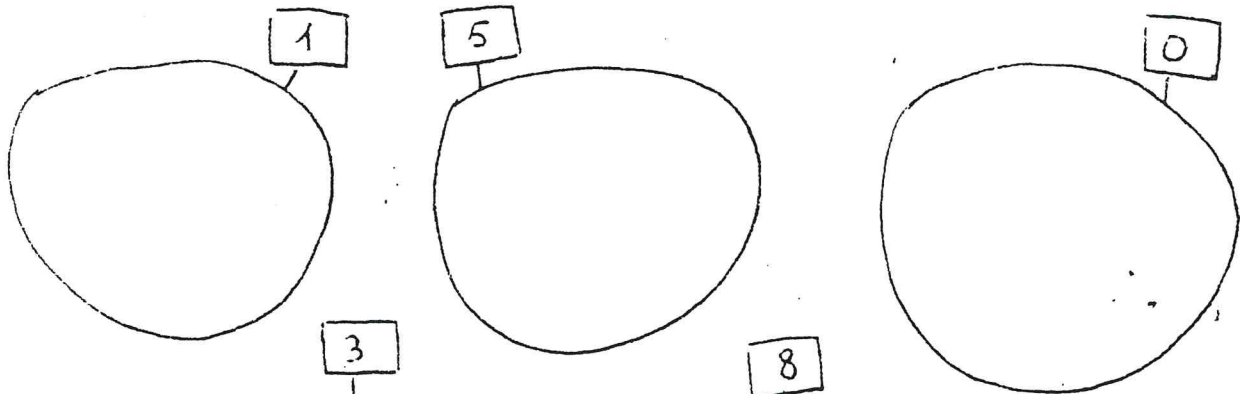

DISEGNA NELL'INSIEME TANTI ELEMENTI QUANTI
NE INDICA IL NUMERO SCRITTO NEL CARTELLINO

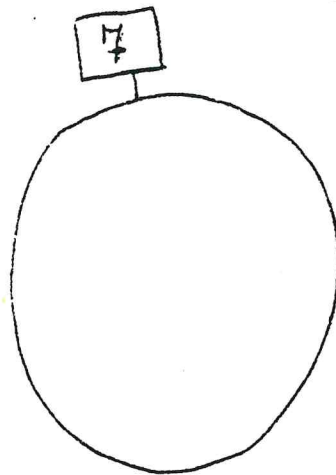
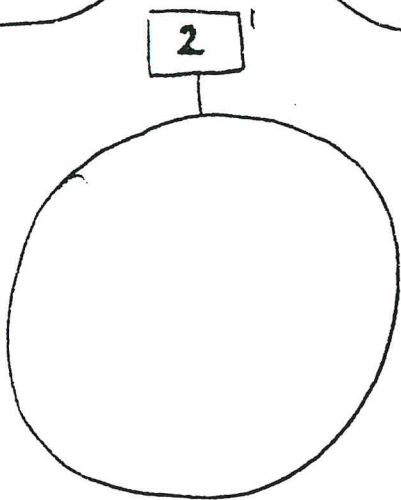
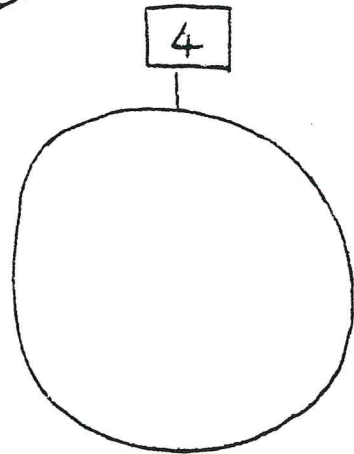
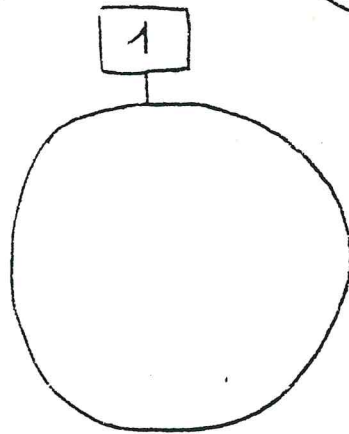
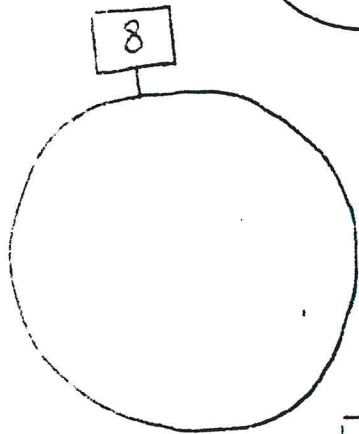
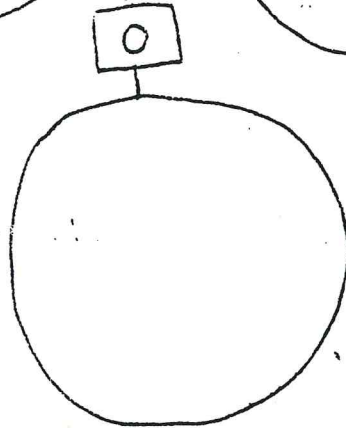
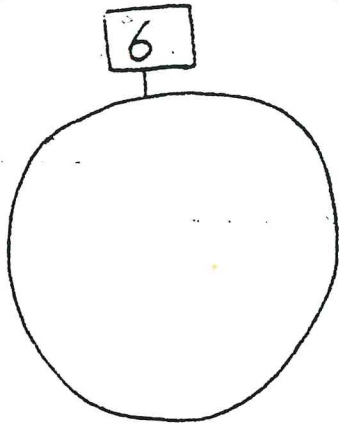
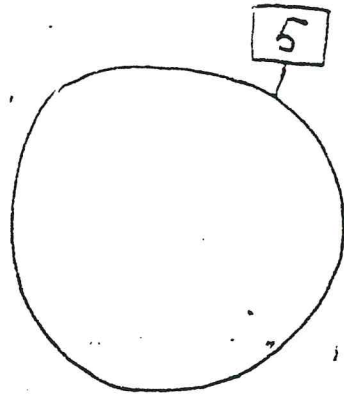
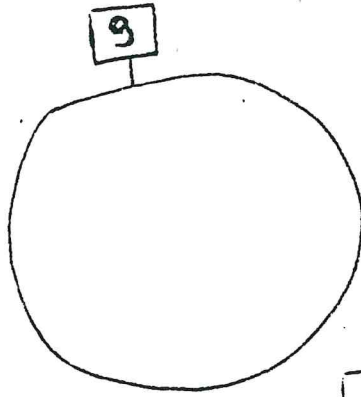
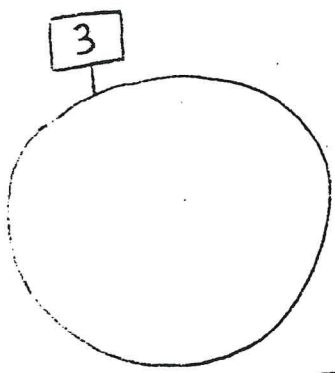

DISEGNA NELL'INSIEME TANTI ELEMENTI QUANTI
NE INDICA IL NUMERO SCRITTO NEL CARTELLINO

The image shows ten hand-drawn circles arranged in four rows. Each circle has a small square sign above it, connected by a short vertical line. The numbers in the signs are: 6, 2, 7, 4, 9, 2, 6, 4, 9, 7.

0

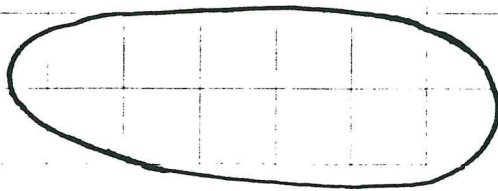

SEI

1

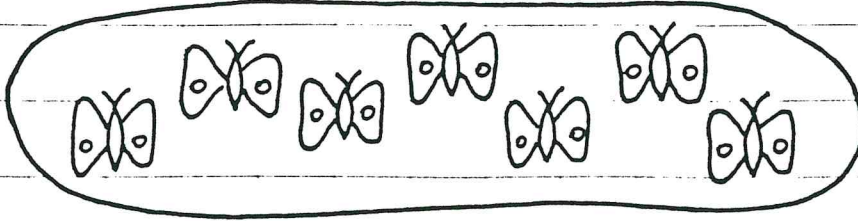

QUATTRO

2

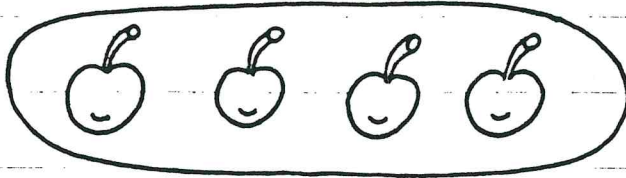

ZERO

3

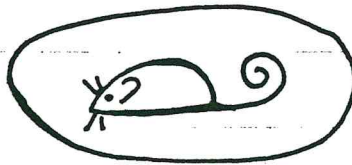

UNO

4

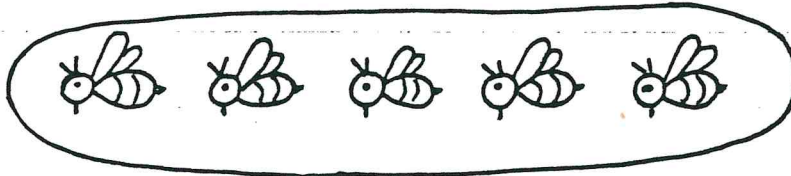

DUE

5

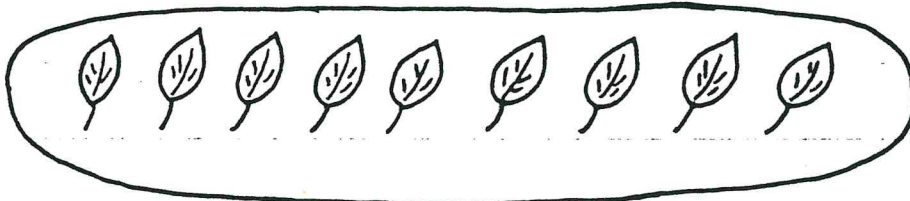

OTTO

6

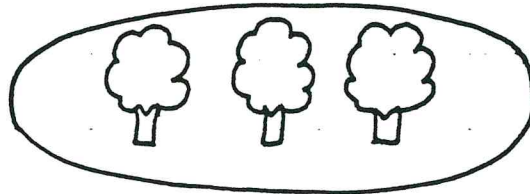

TRE

7

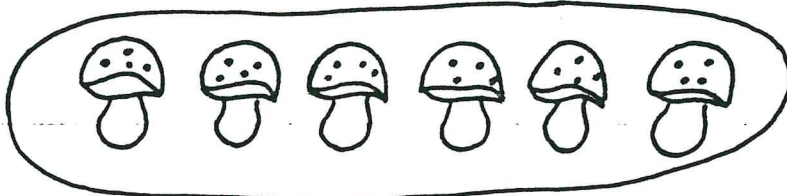

CINQUE

8

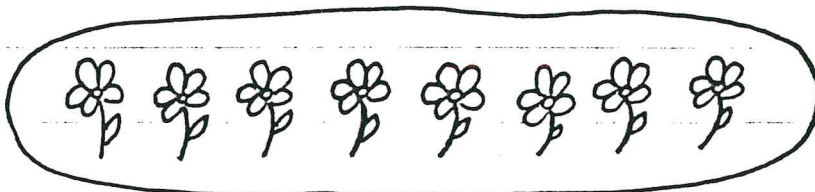

SETTE

9

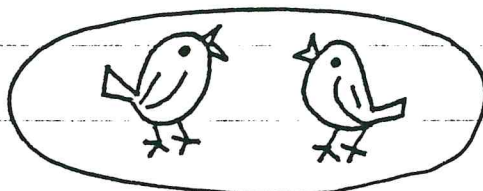

NOVE

COMPLETA LE LINEE DEI NUMERI

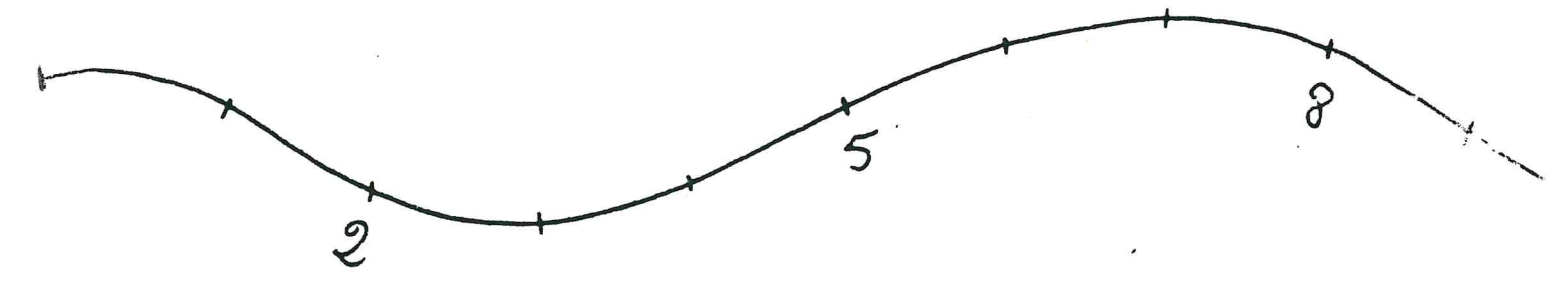
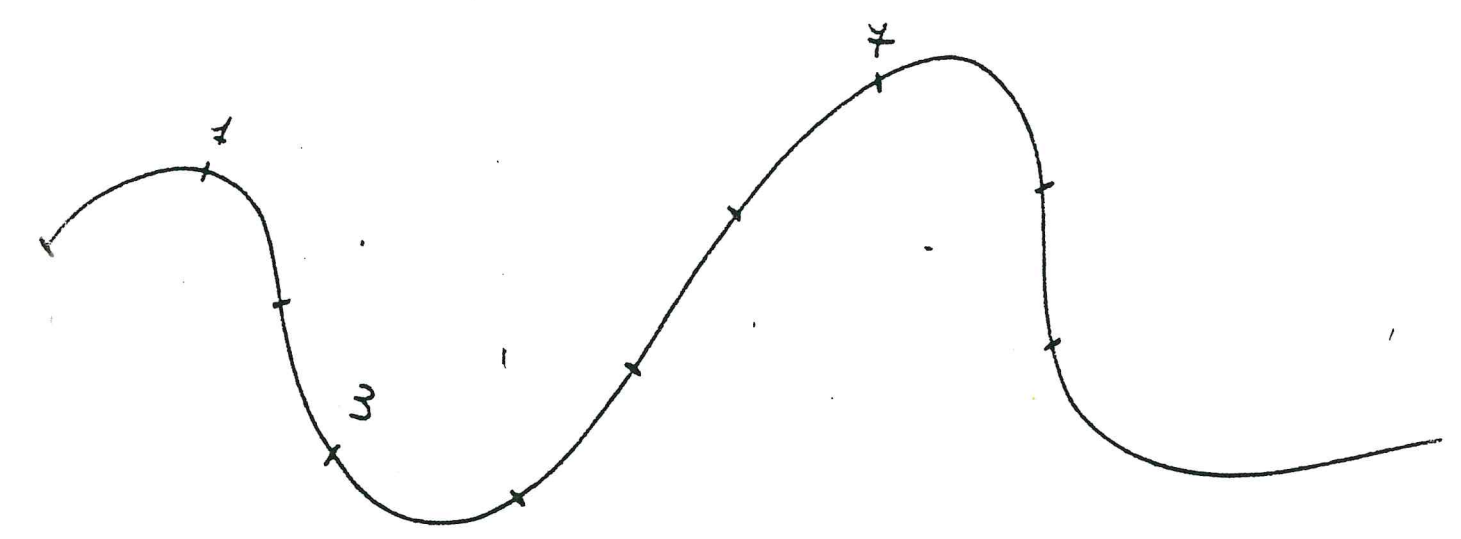
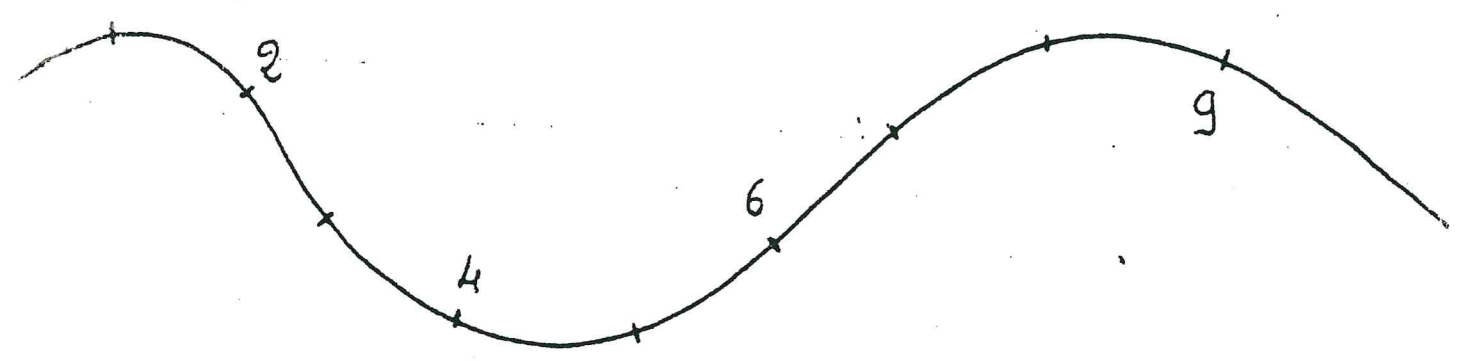

COMPLETA LE LINEE DEI NUMERI

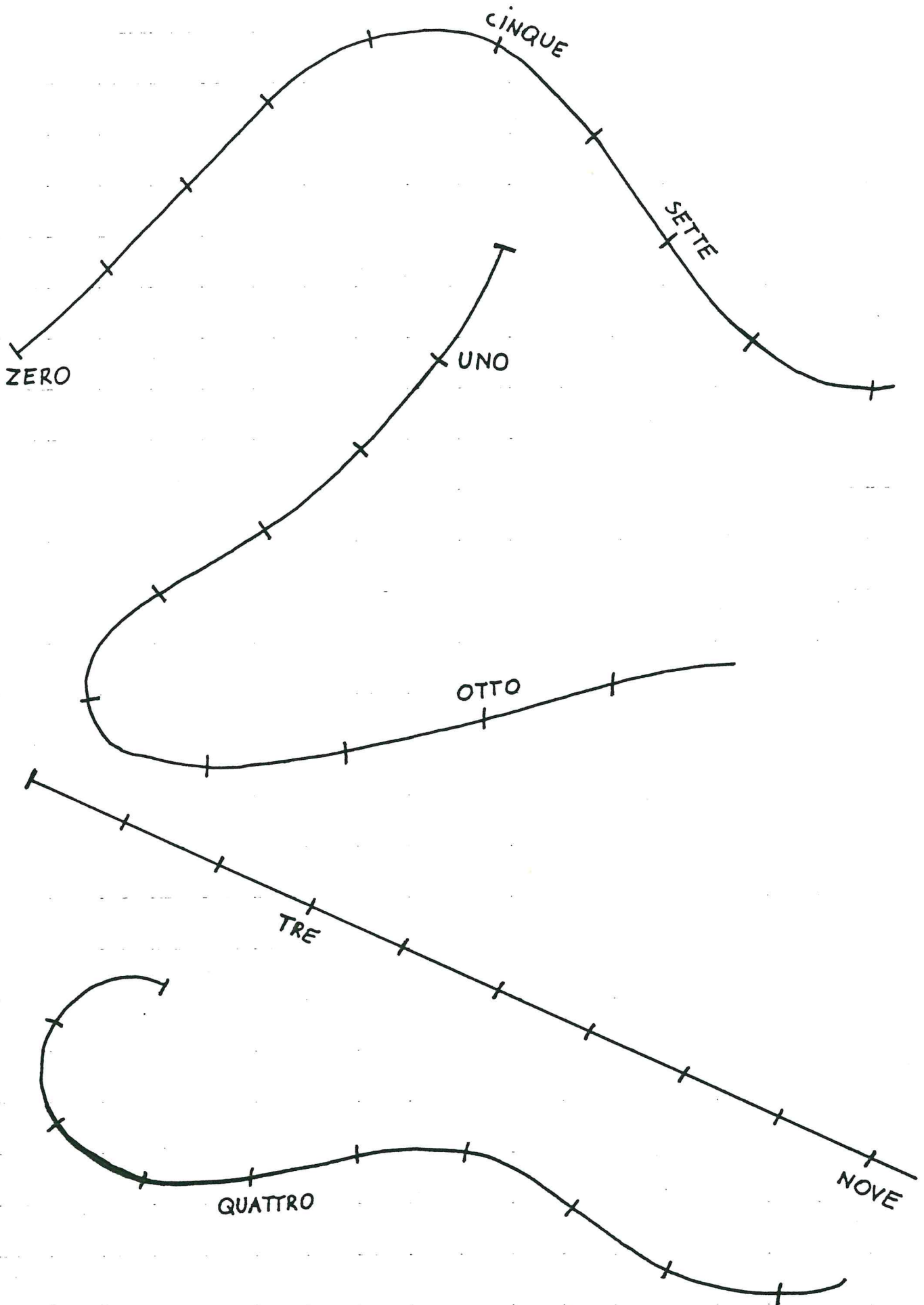

0	
5	
7	
2	
9	

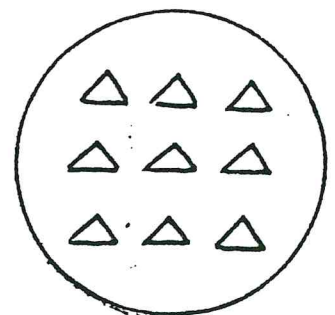
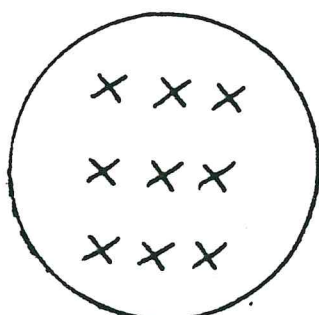
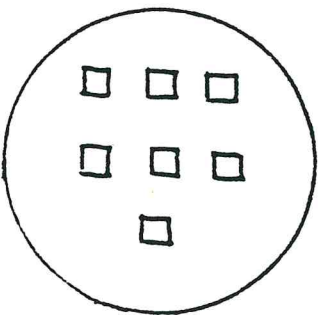
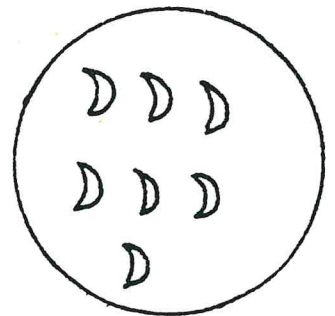
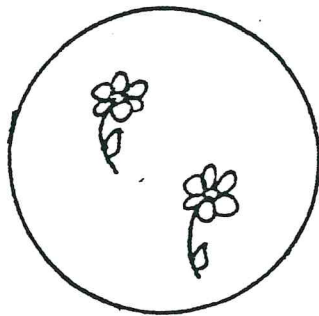
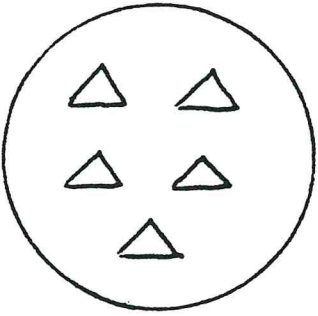
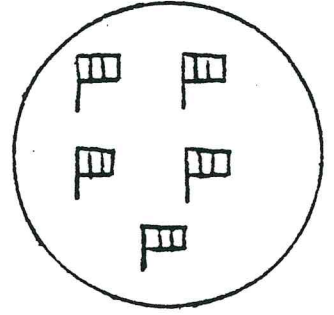
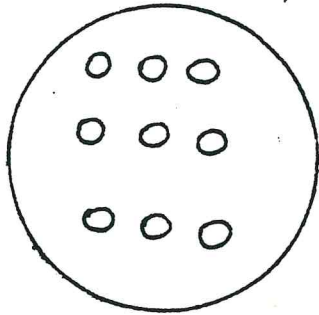
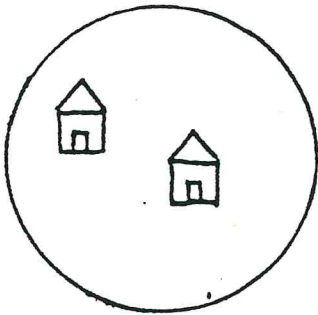
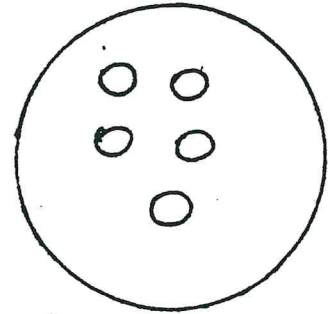
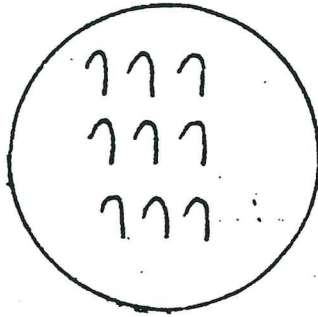
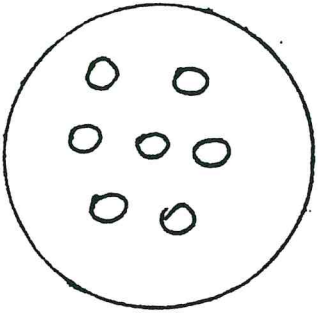
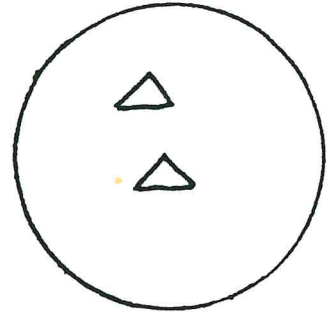
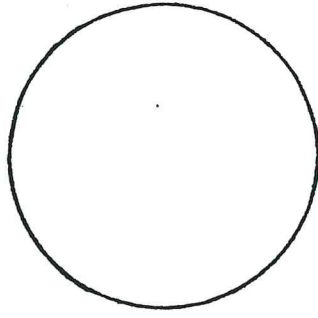
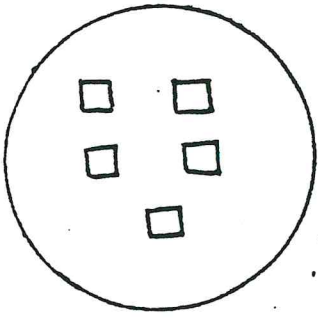

- 1 -

117/10

2					
6					
1					
8					
4					

SCOPRI LA FIGURA NASCOSTA SEGUENDO I PUNTINI

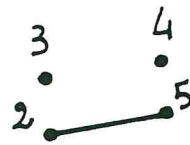
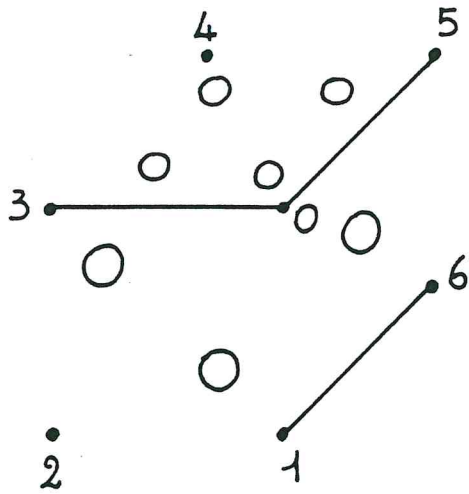

1.



3.

5.

4.

6.

0.

9.

8.

7.

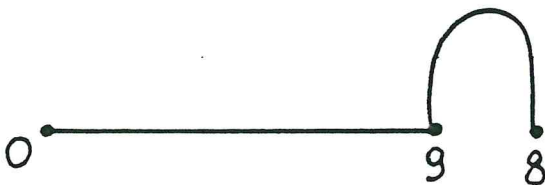

SCOPRI LA FIGURA NASCOSTA SEGUENDO I PUNTINI
(ENTRO 10)

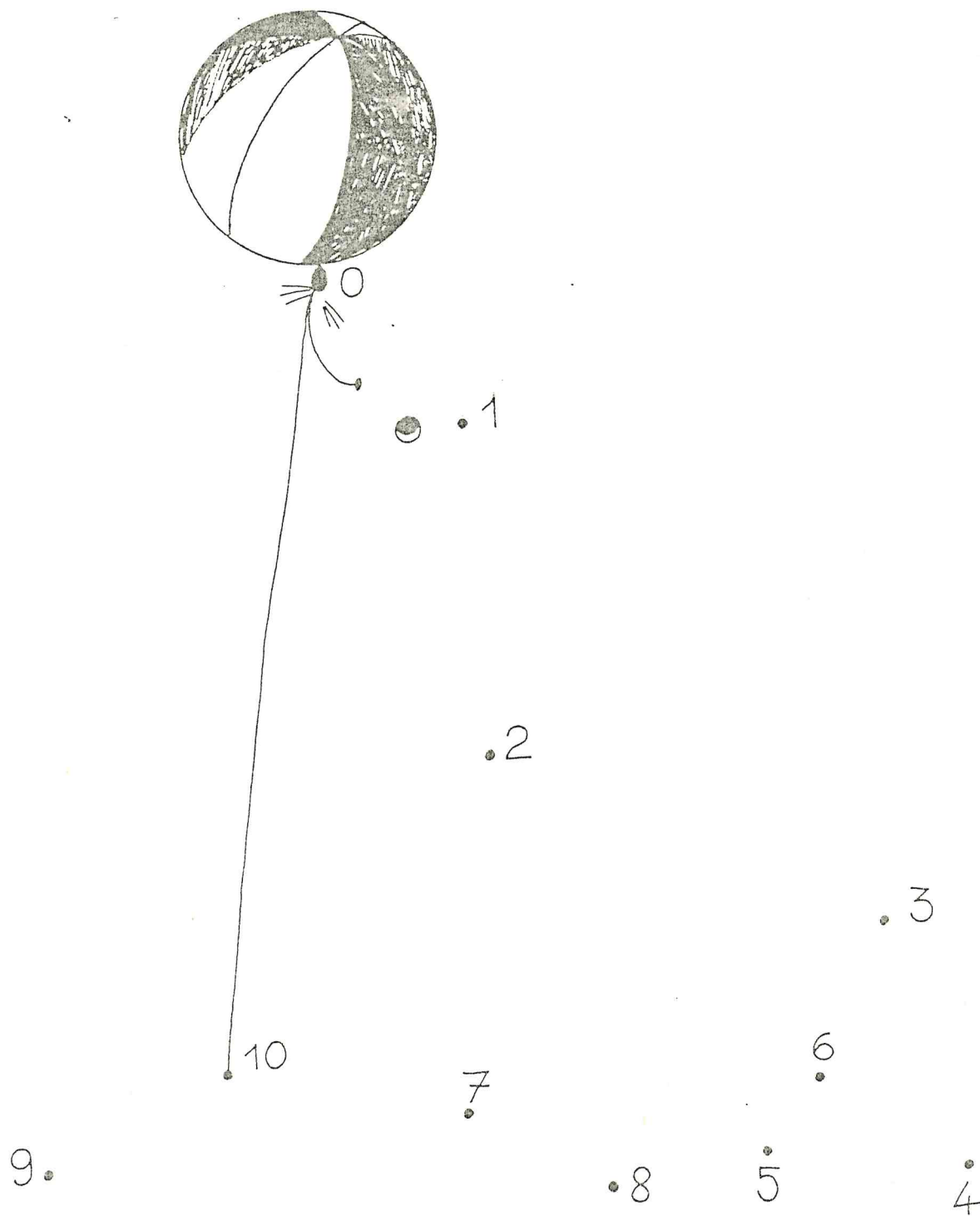

Ricognizione dell'ordine progressivo dei numeri da 0 a 10

Scopri la figura nascosta seguendo i puntini

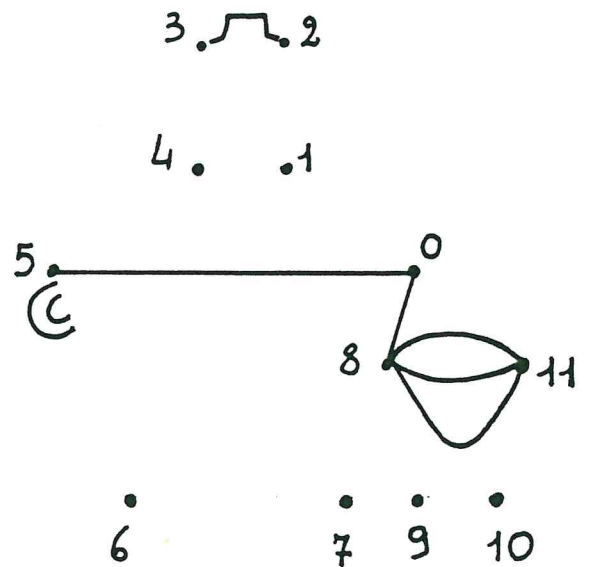
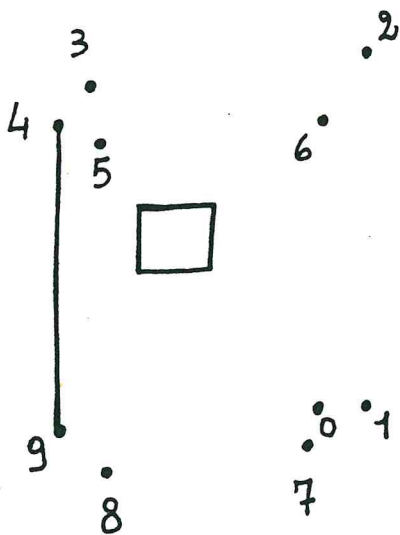
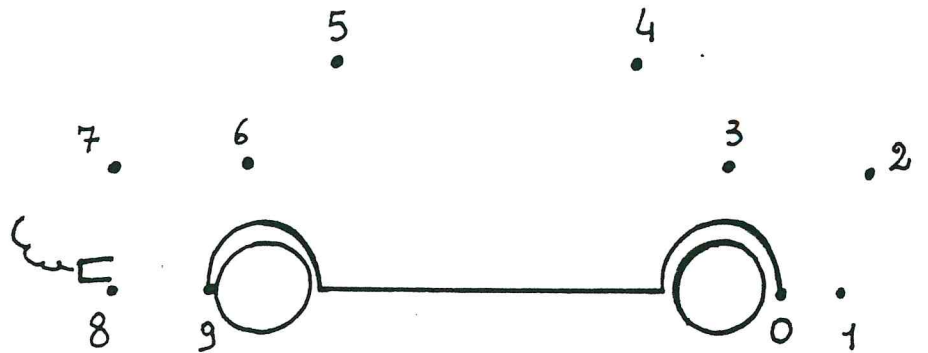
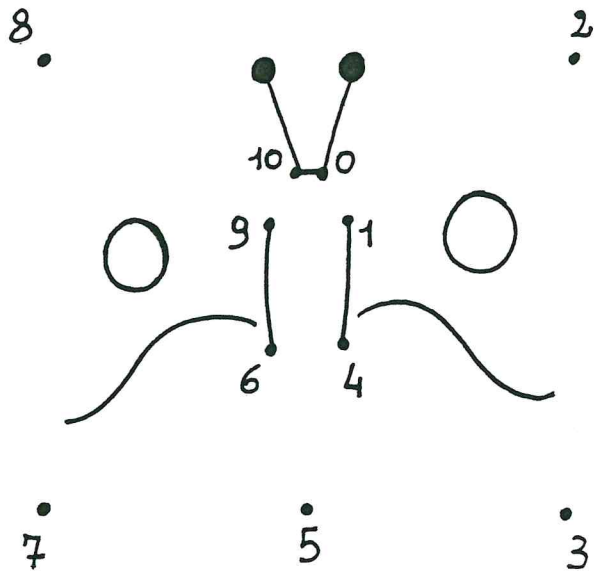

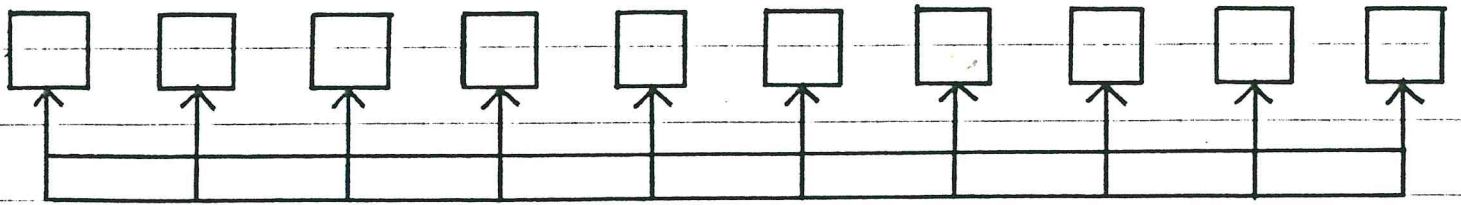

Mirco ha fatto 9 passi

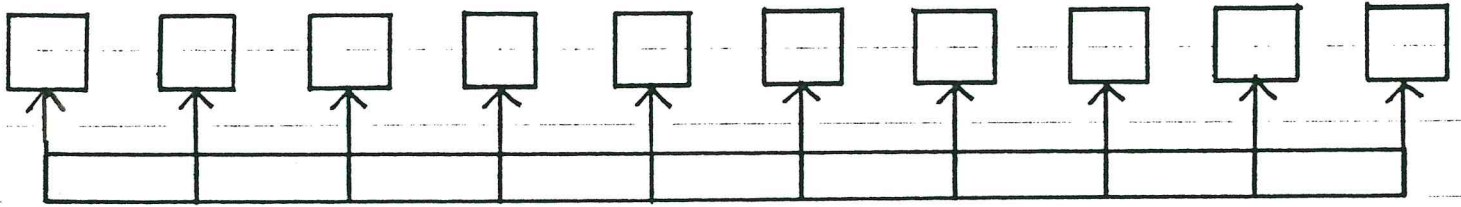

Renée ha fatto 2 passi in meno di Mirco

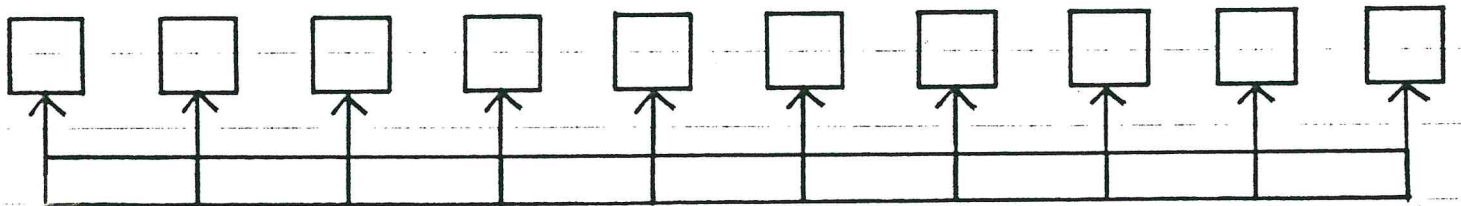

Moana ha fatto 3 passi

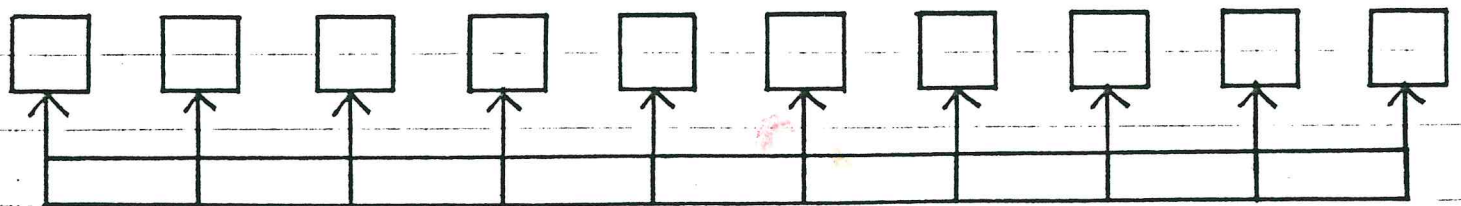

Manuel ha fatto 3 passi in più di Moana

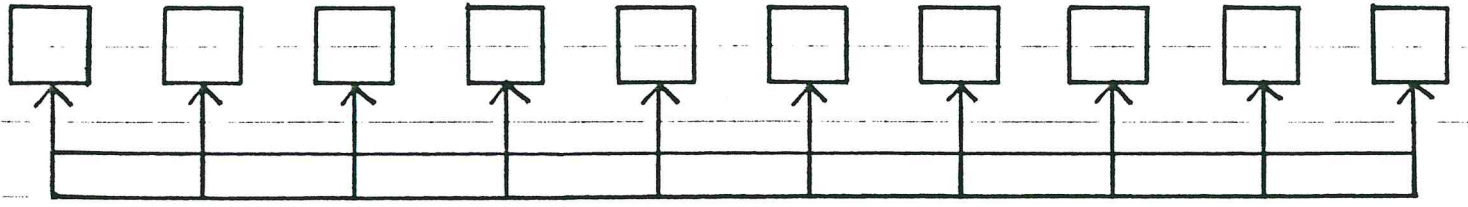

Simone ha fatto 6 passi.

Lodovico ha fatto 2 passi in più di Simone.

Tiziana ha fatto 1 passo in meno di Simone.

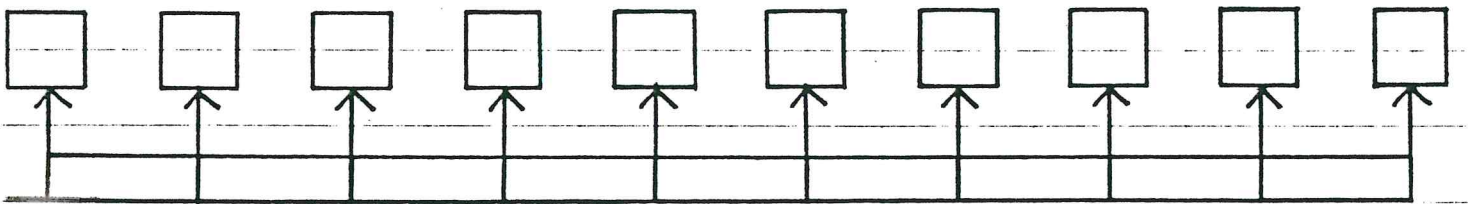

Roberta ha fatto 2 passi.

Massimiliano ha fatto 2 passi in meno di Roberta.

Francesca ha fatto 4 passi in più di Roberta.

M. Grazia ha fatto 7 passi in più di Roberta.

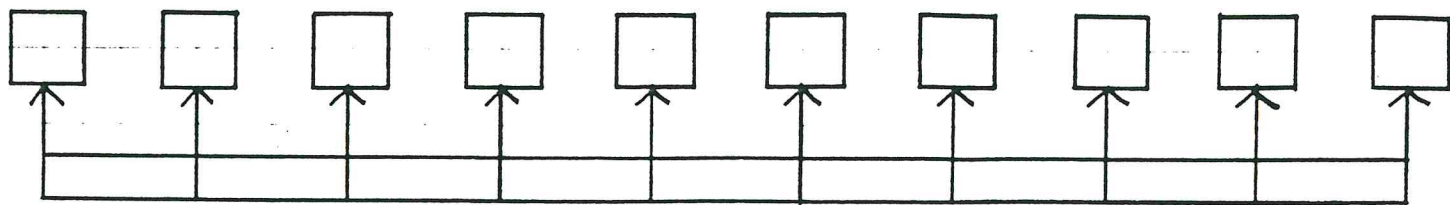

Roberta ha fatto 4 passi

Giorgia ha fatto 4 passi in più di Roberta

Manuel ha fatto 1 passo in meno di Giorgia

Simone ha fatto 3 passi in meno di Roberta

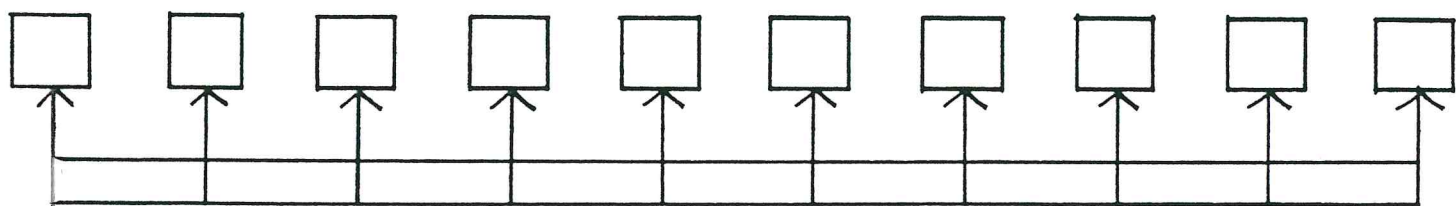

Filippo ha fatto 1 passo

Francesca ha fatto 8 passi in più di Filippo

Moana ha fatto 2 passi in meno di Francesca

Mirco ha fatto 4 passi in più di Filippo

DISEGNA UN INSIEME CON 1 ELEMENTO IN
MENO E UN INSIEME CON 1 ELEMENTO IN PIU'
 DELL' INSIEME DATO.

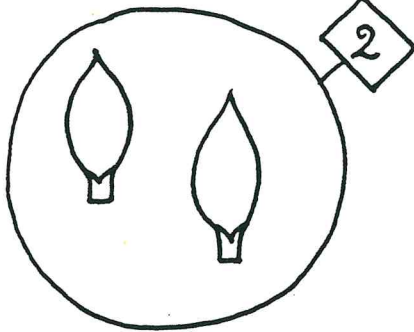
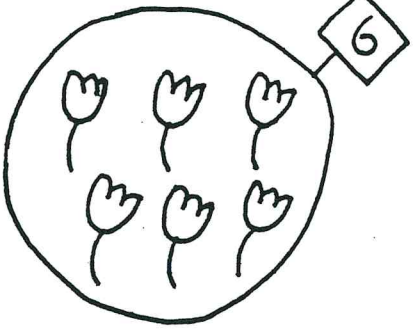
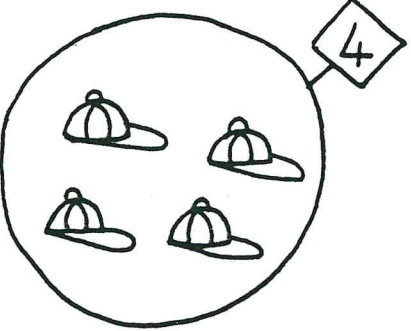
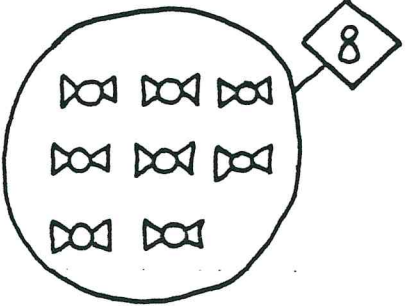
PRIMA	INSIEME DATO	DOPO
		
		
		
		

Metti il numero giusto nel cartellino

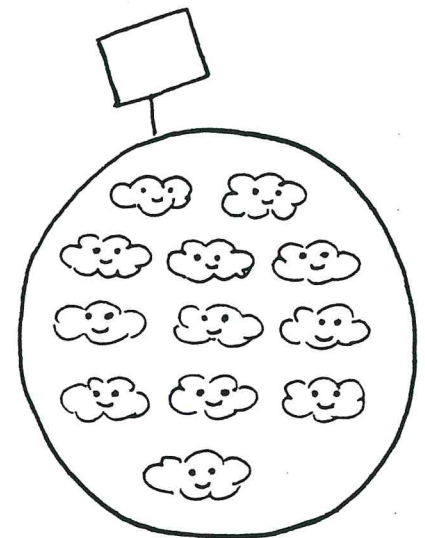
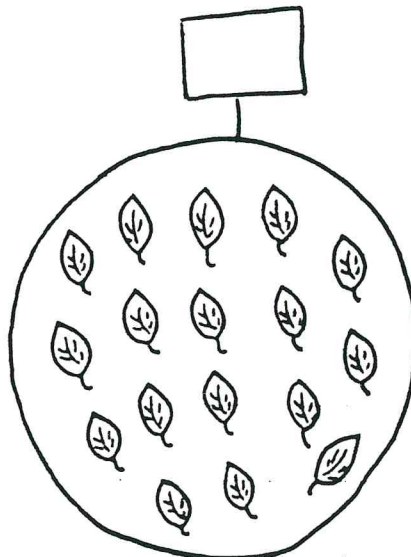
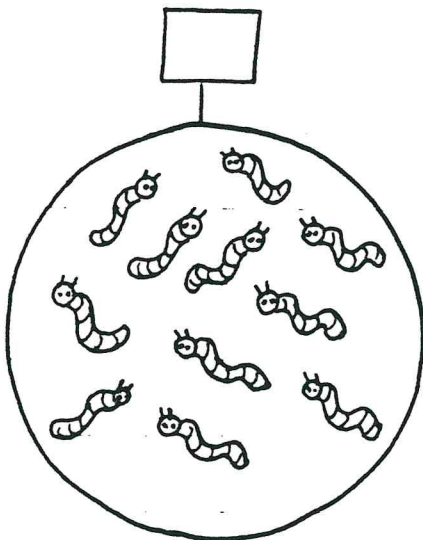
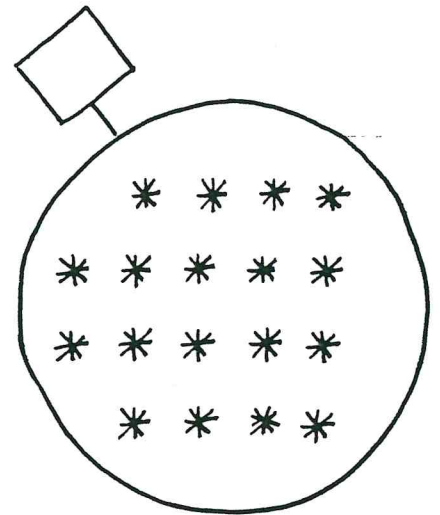
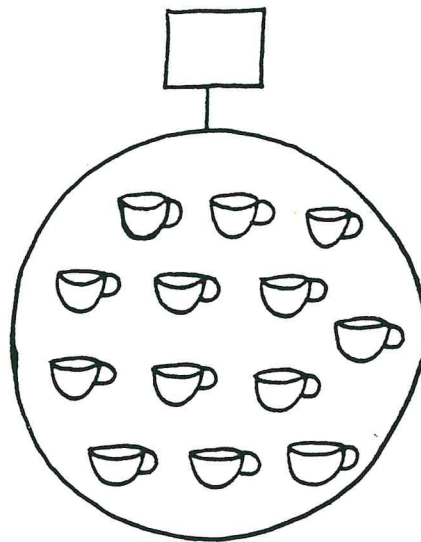
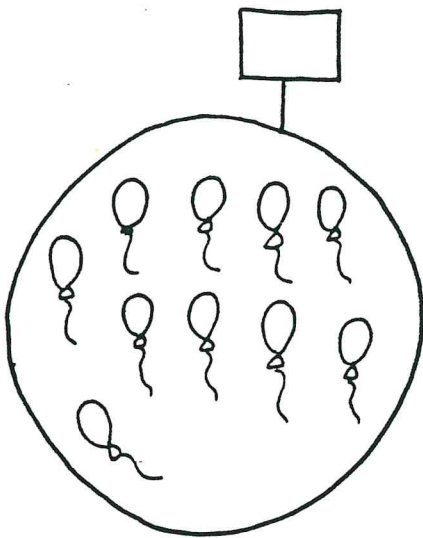
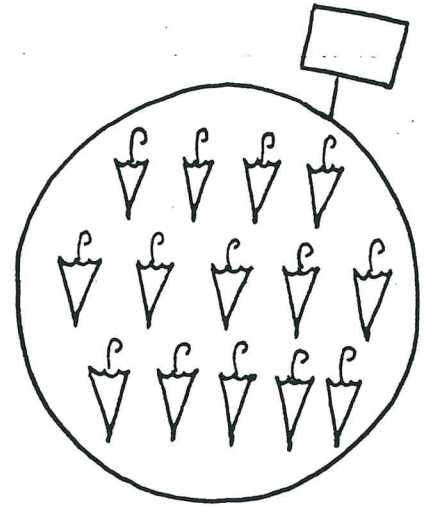
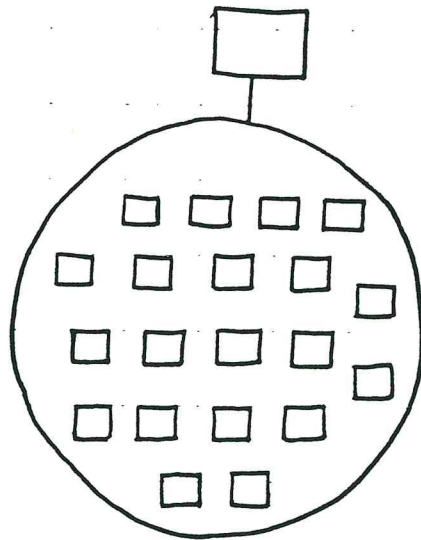
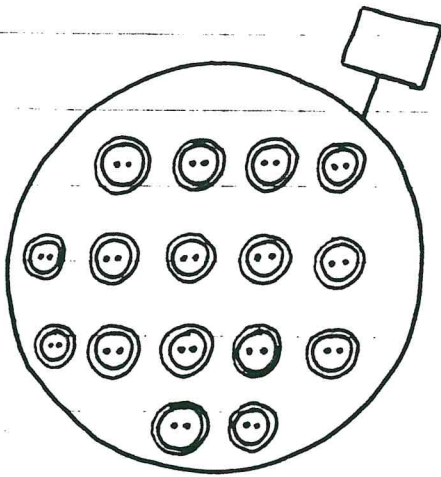

Scrivi la parola corrispondente al numero

18 →

11 →

3 →

15 →

6 →

16 →

10 →

8 →

20 →

13 →

1 →

19 →

14 →

17 →

12 →

5 →

Scrivi il numero corrispondente alla parola

QUATTORDICI →

VENTI →

UNDICI →

SETTE →

DICIANNOVE →

DODICI →

ZERO →

QUINDICI →

DICIASSETTE →

DIECI →

QUATTRO →

TREDICI →

NOVE →

DICIOTTO →

DUE →

SEDICI →

Completa le linee dei numeri

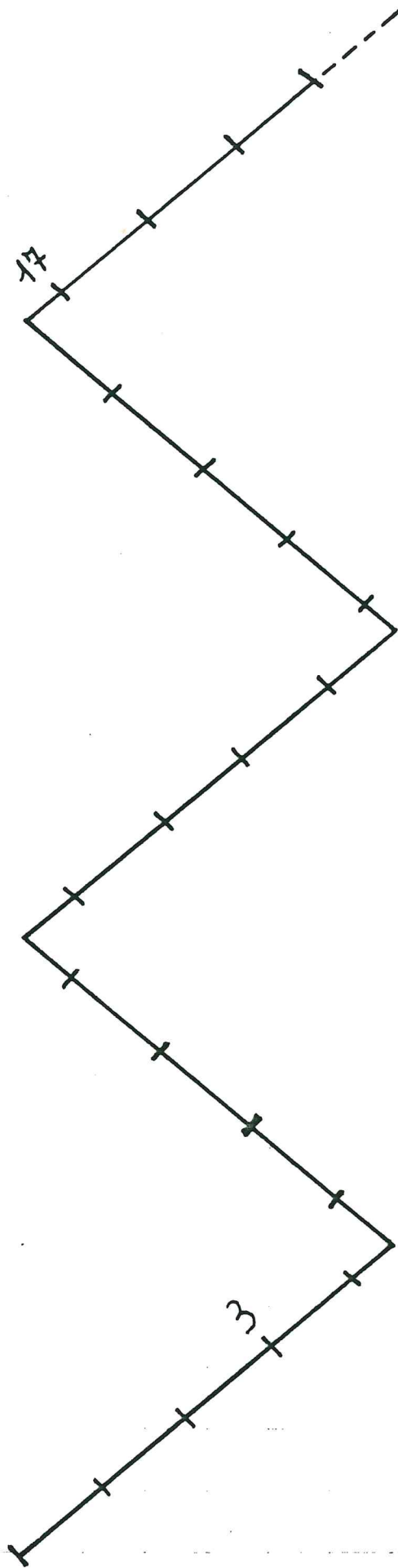
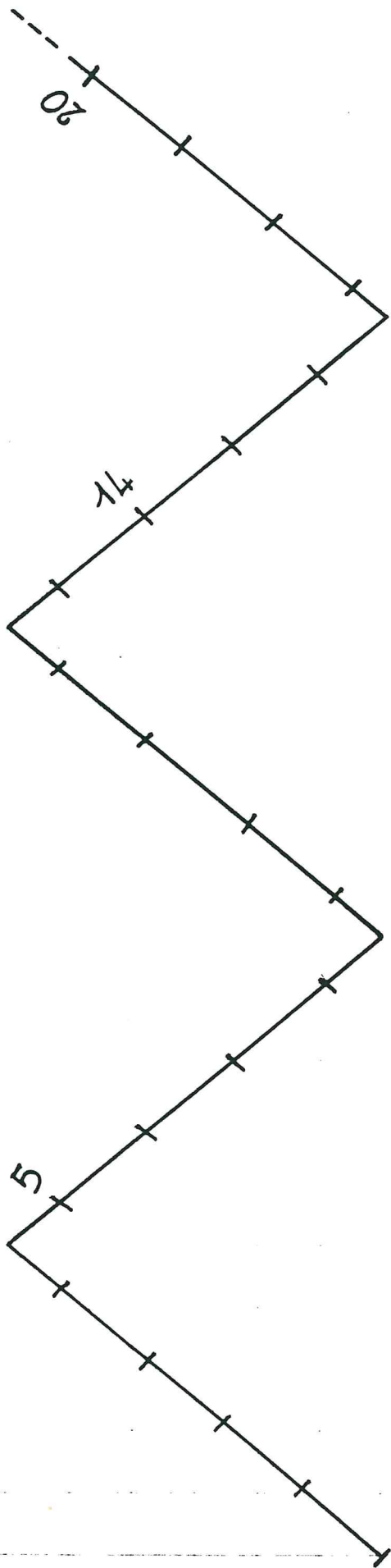

Completa la linea dei numeri , scrivendo i

numeri che mancano nelle bandierine

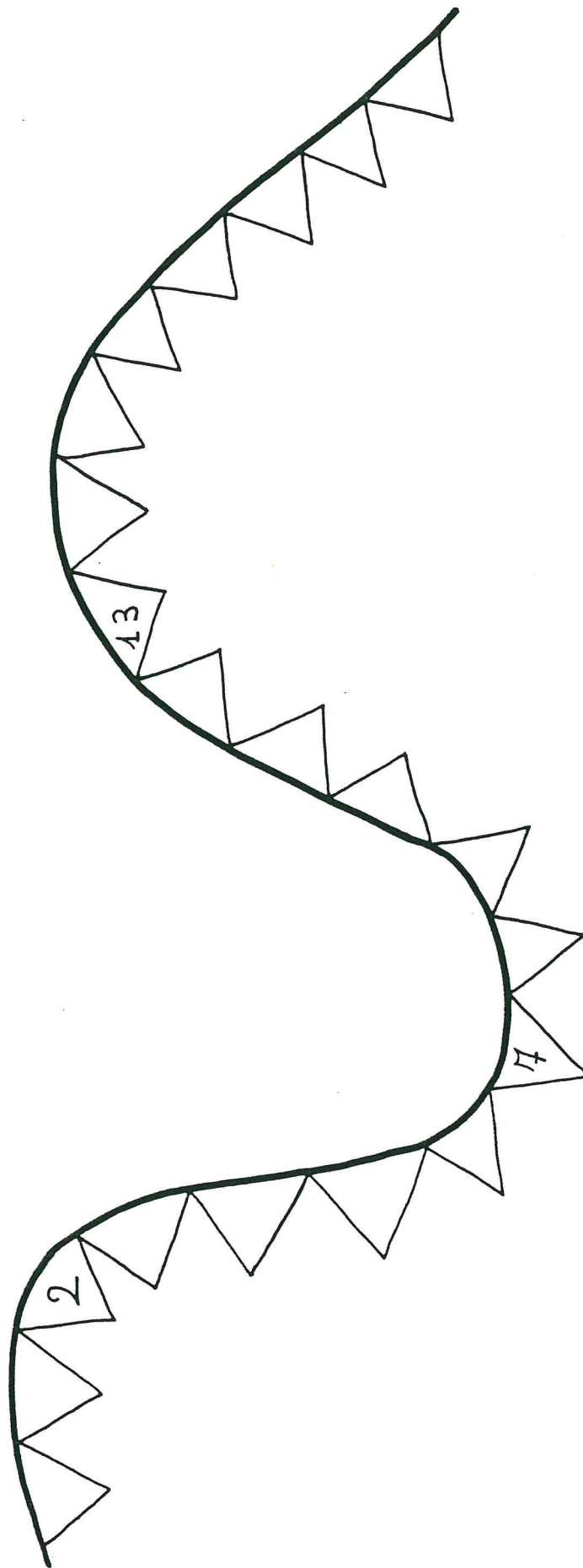

Completa le linee dei numeri

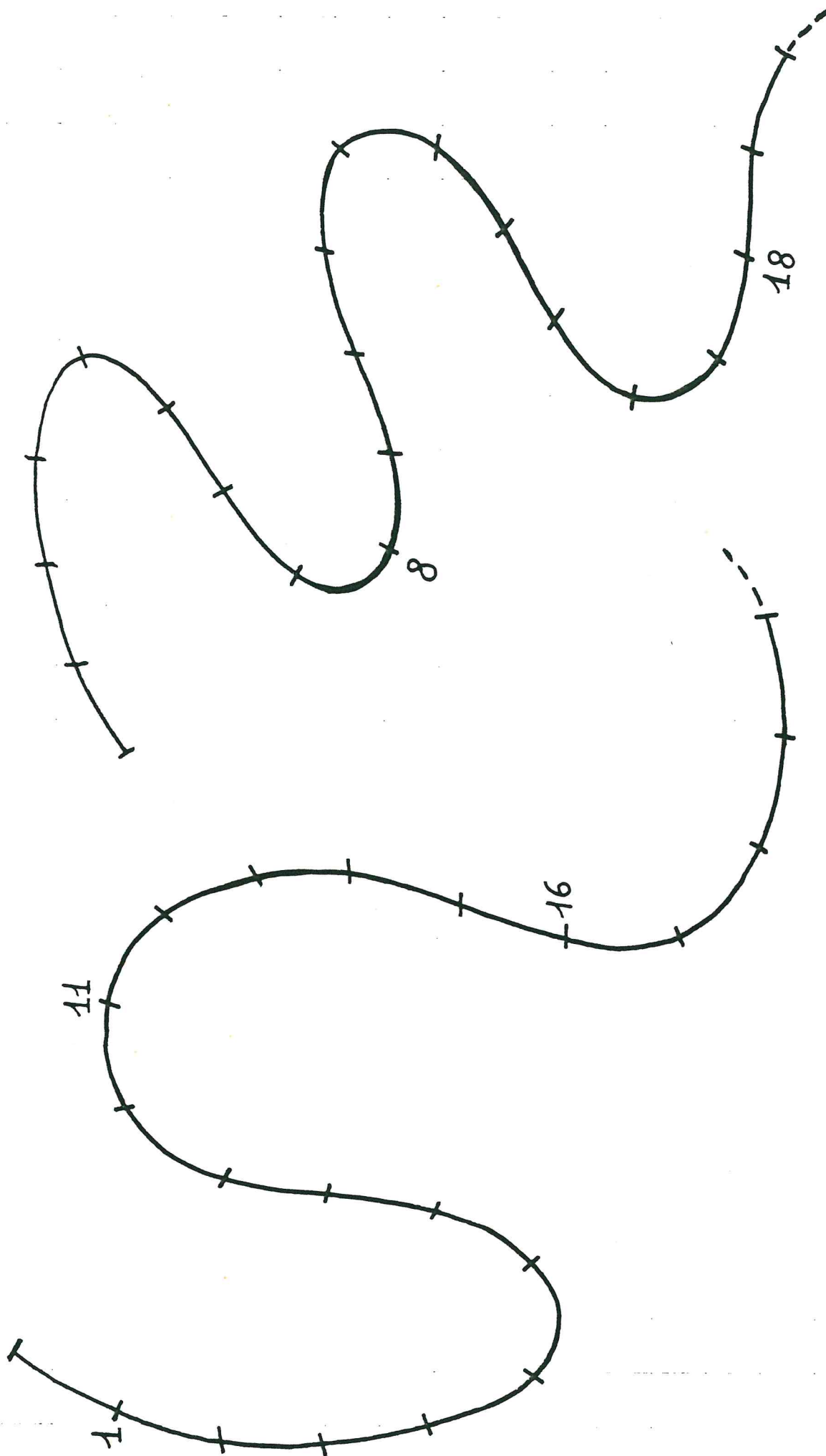

Completa , con le parole , la linea dei numeri

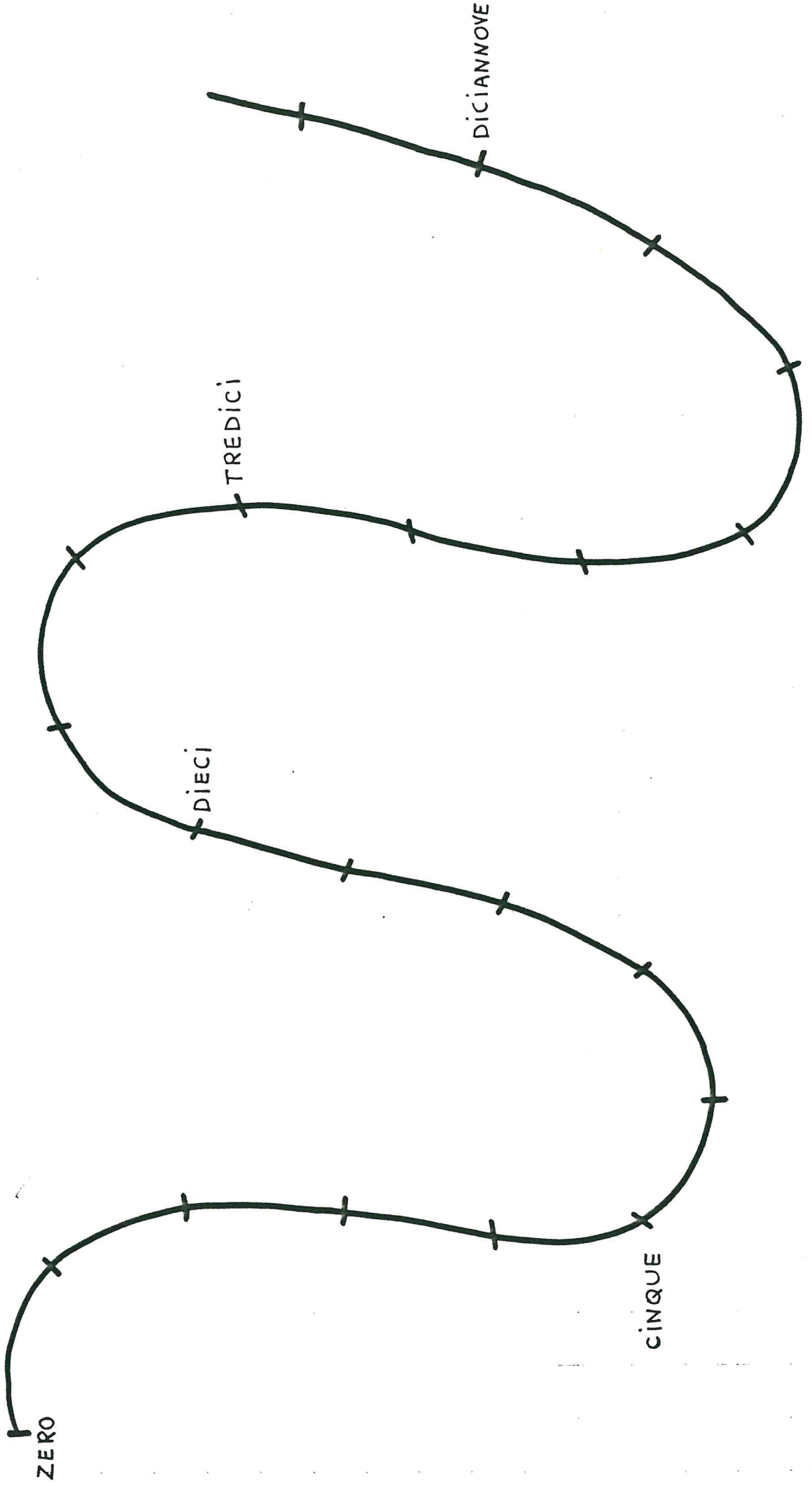

Scopri le figure nascoste

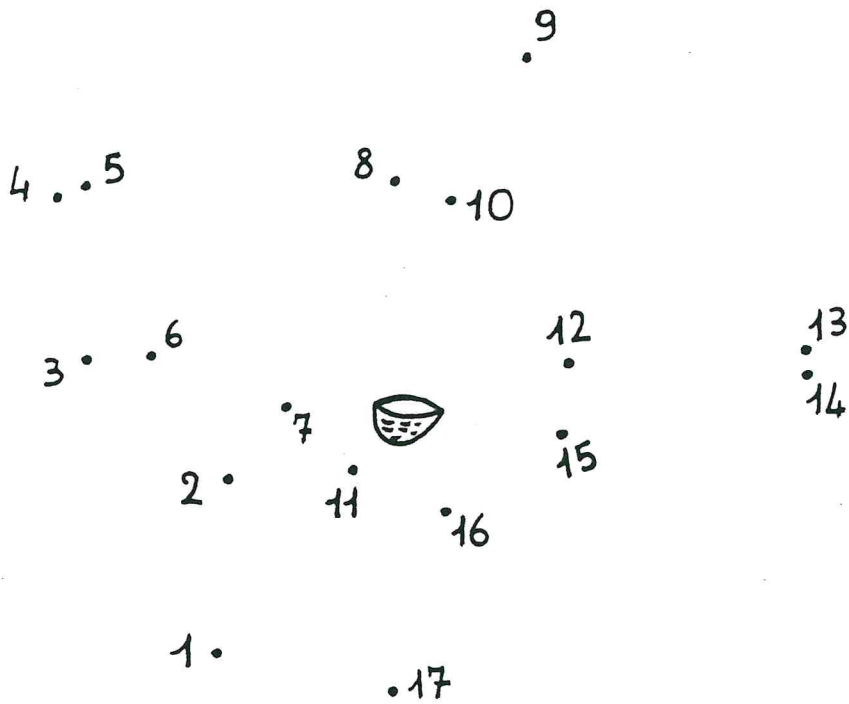
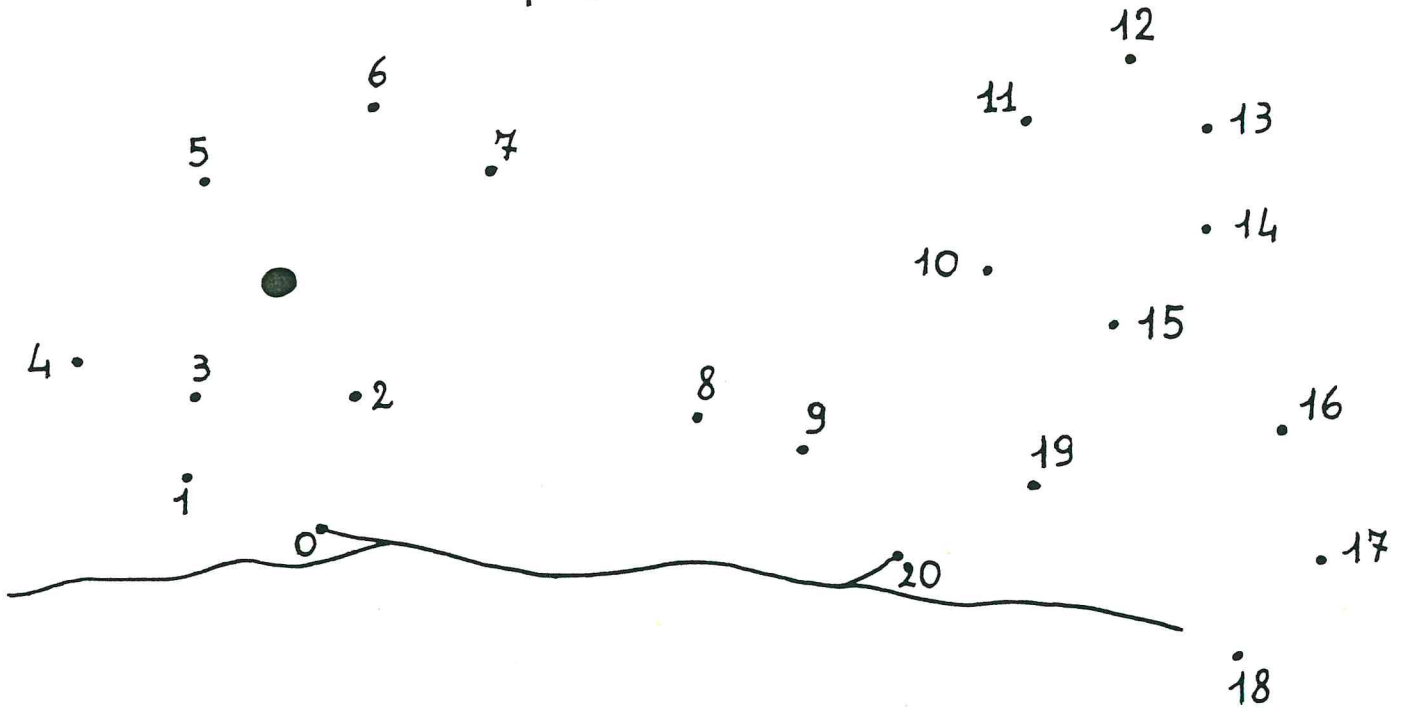

FAI DEGLI INSIEMI CON --- ELEMENT_



Fra questi insiemi usa i simboli

$<$ (minore) $>$ (maggiore) $=$ (uguale)

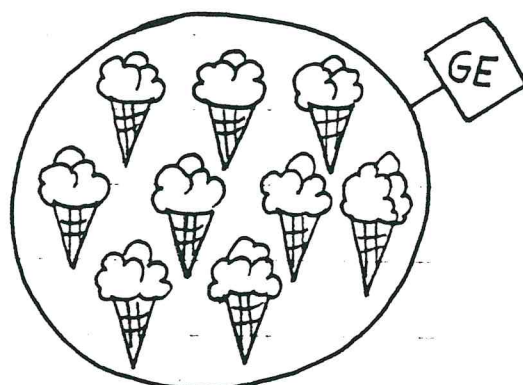
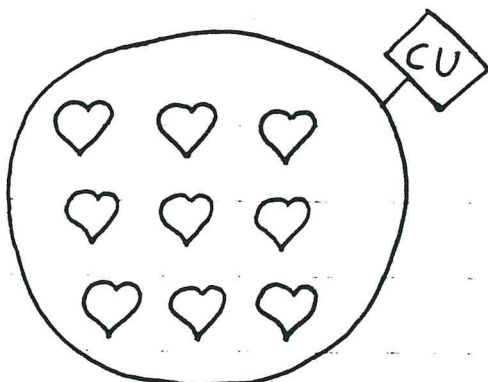
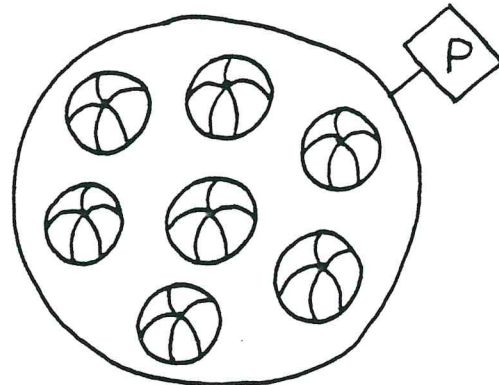
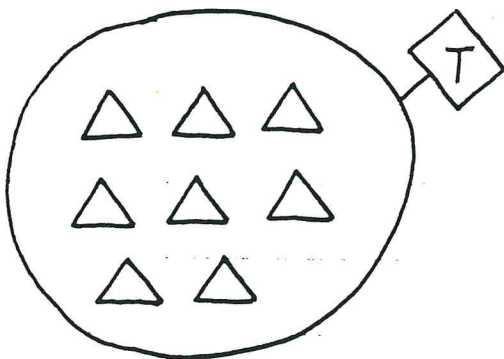
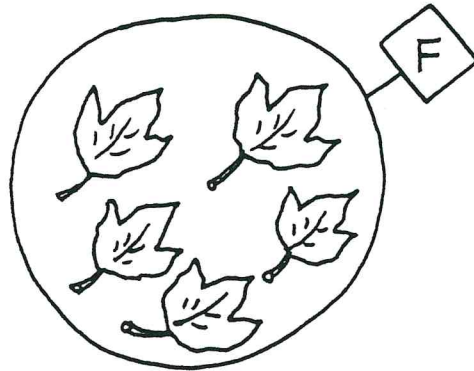
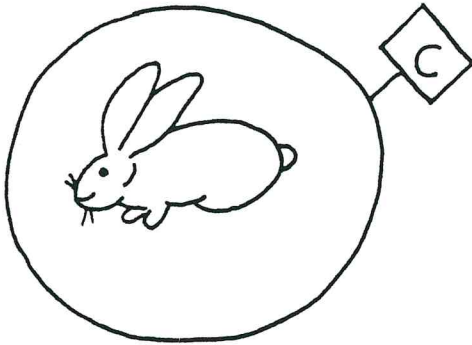
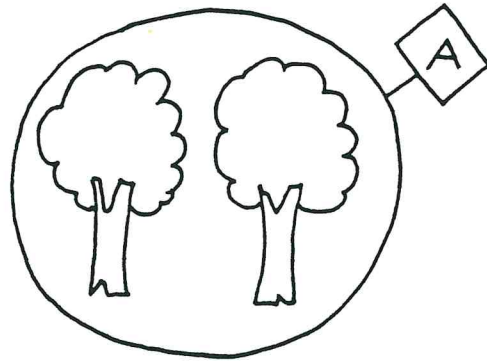
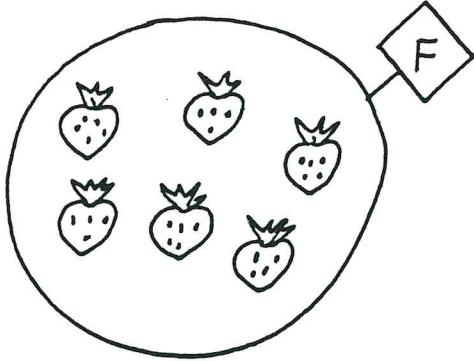

Fra questi insiemi usa i simboli

< (minore) > (maggiore) = (uguale)

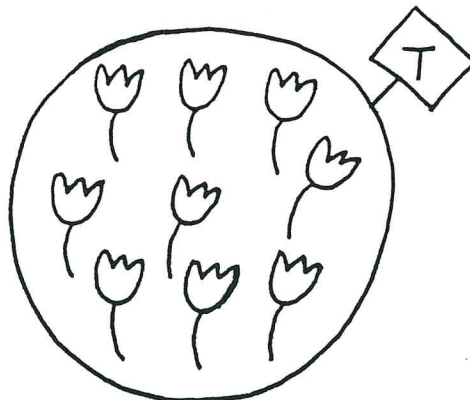
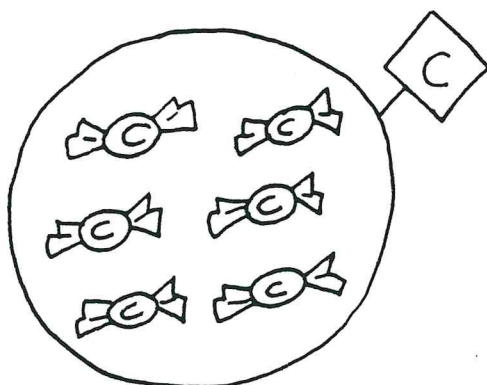
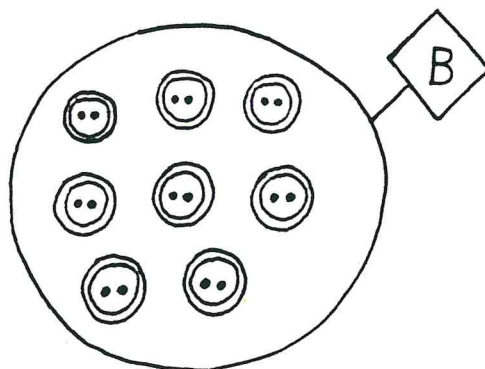
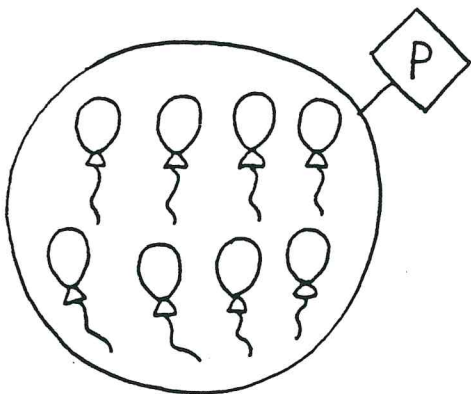
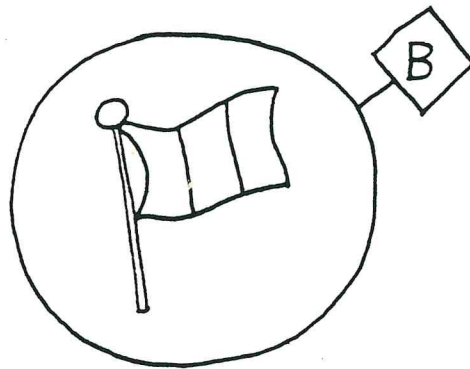
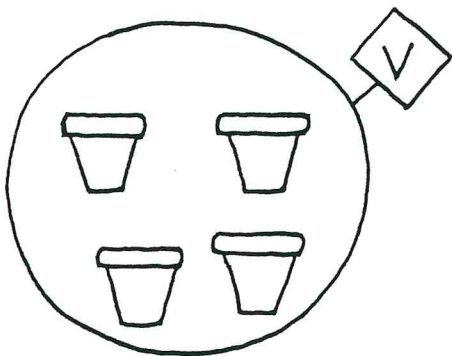
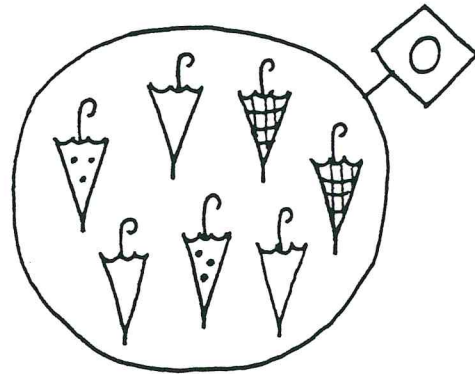
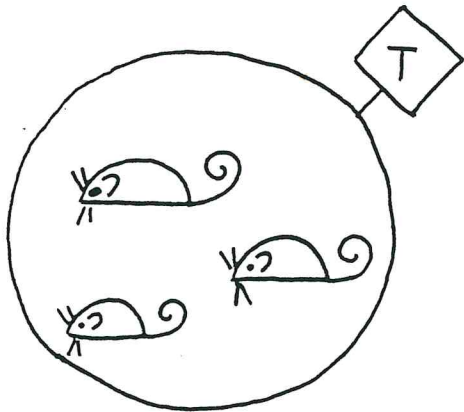

CERCHIA COL ROSSO IL NUMERO MAGGIORE E

COL BLU IL NUMERO MINORE

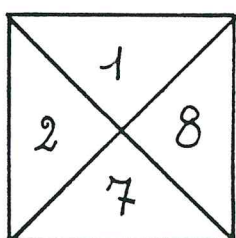
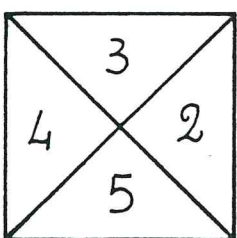
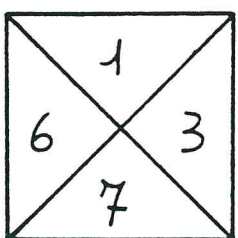
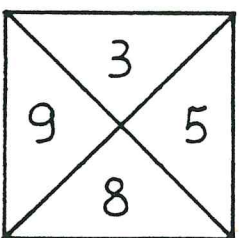
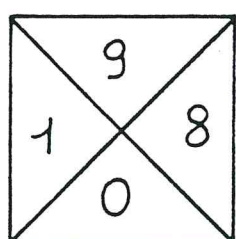
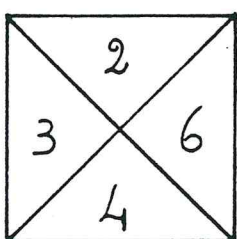
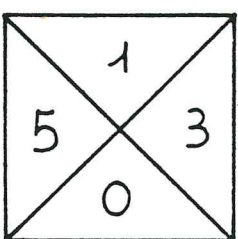
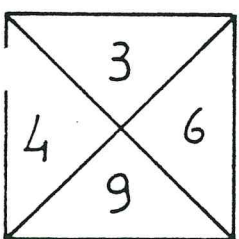
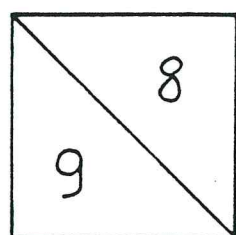
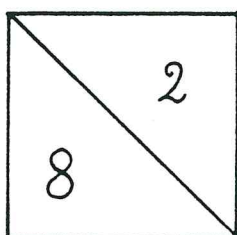
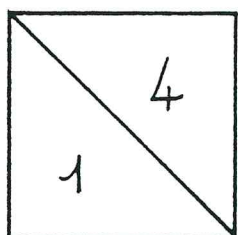
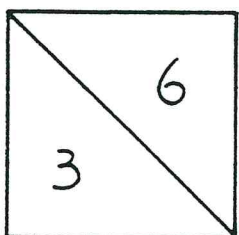
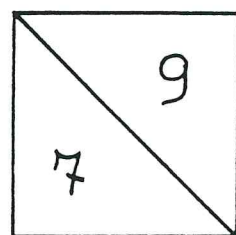
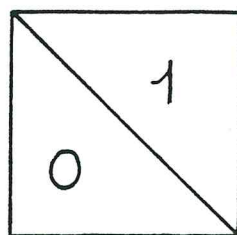
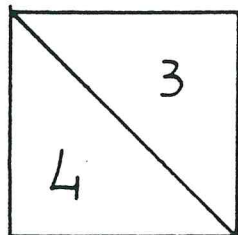
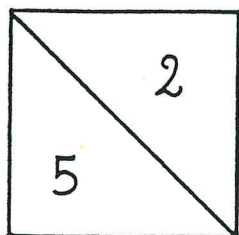

Qual è il numero maggiore?

3 - 4

Di quanto?

Qual è il numero maggiore?

8 - 6

Di quanto?

Qual è il numero maggiore?

3 - 7

Di quanto?

Qual è il numero maggiore?

9 - 5

Di quanto?

Operazioni tra insiemi :

- insieme unione (10 schede)

FAI L'INSIEME UNIONE

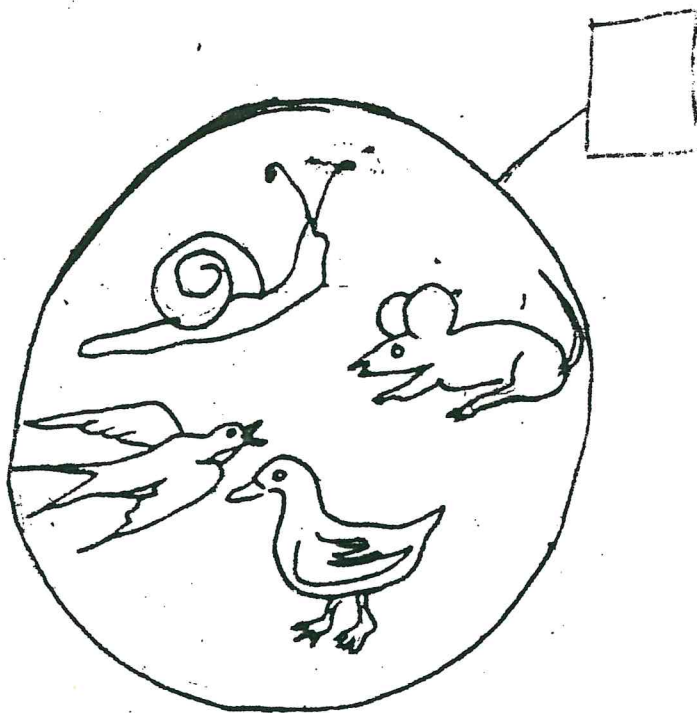
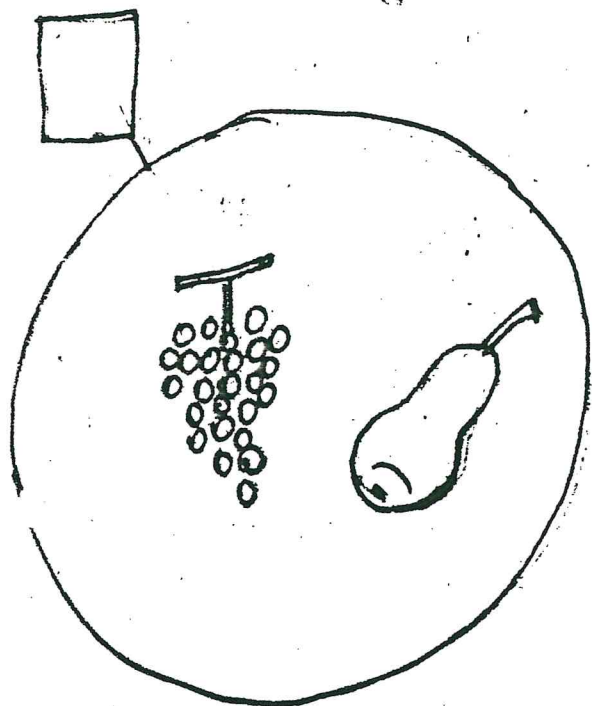

FAI L'INSIEME UNIONE

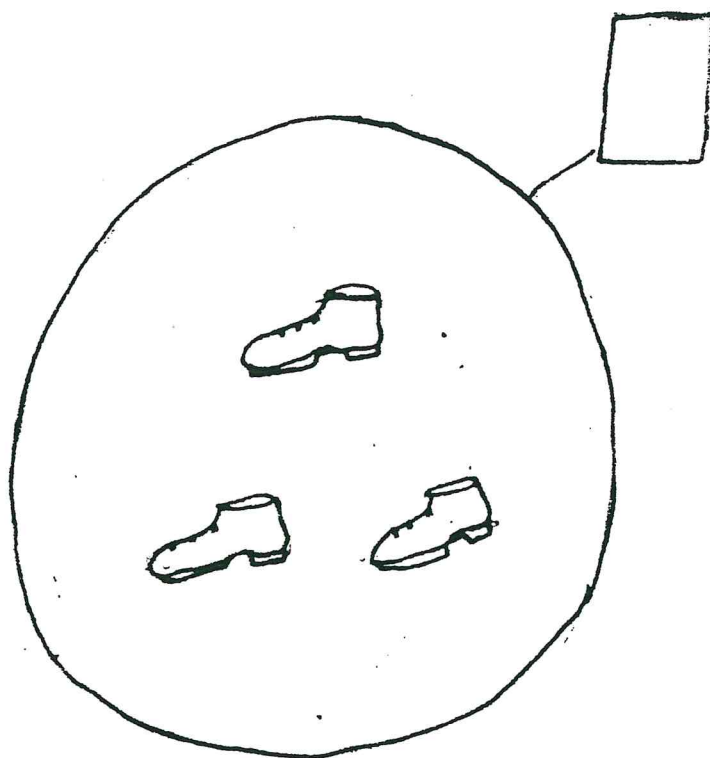
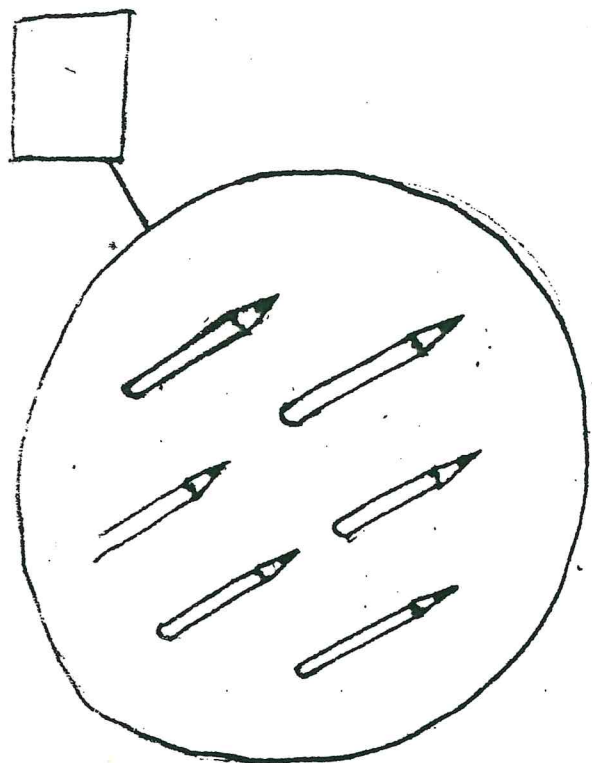

FAI L'INSIEME UNIONE

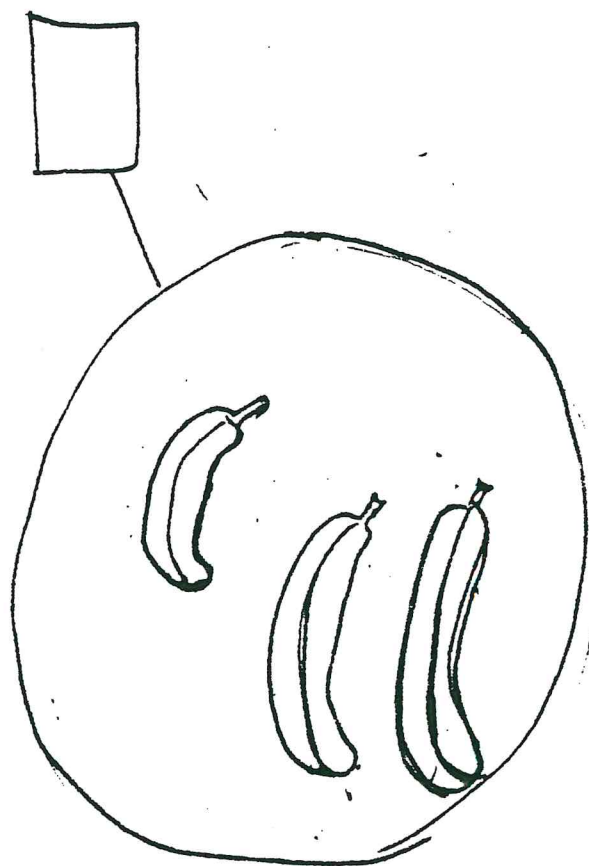
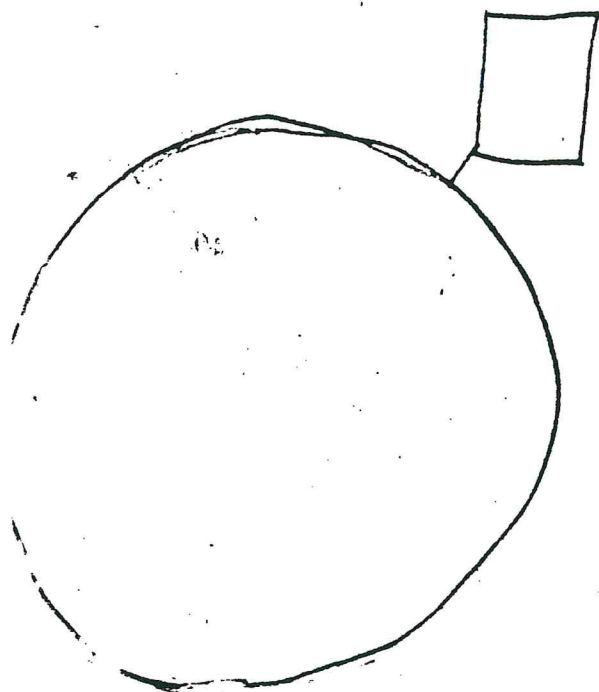

FORMA. L'INSIEME UNIONE.

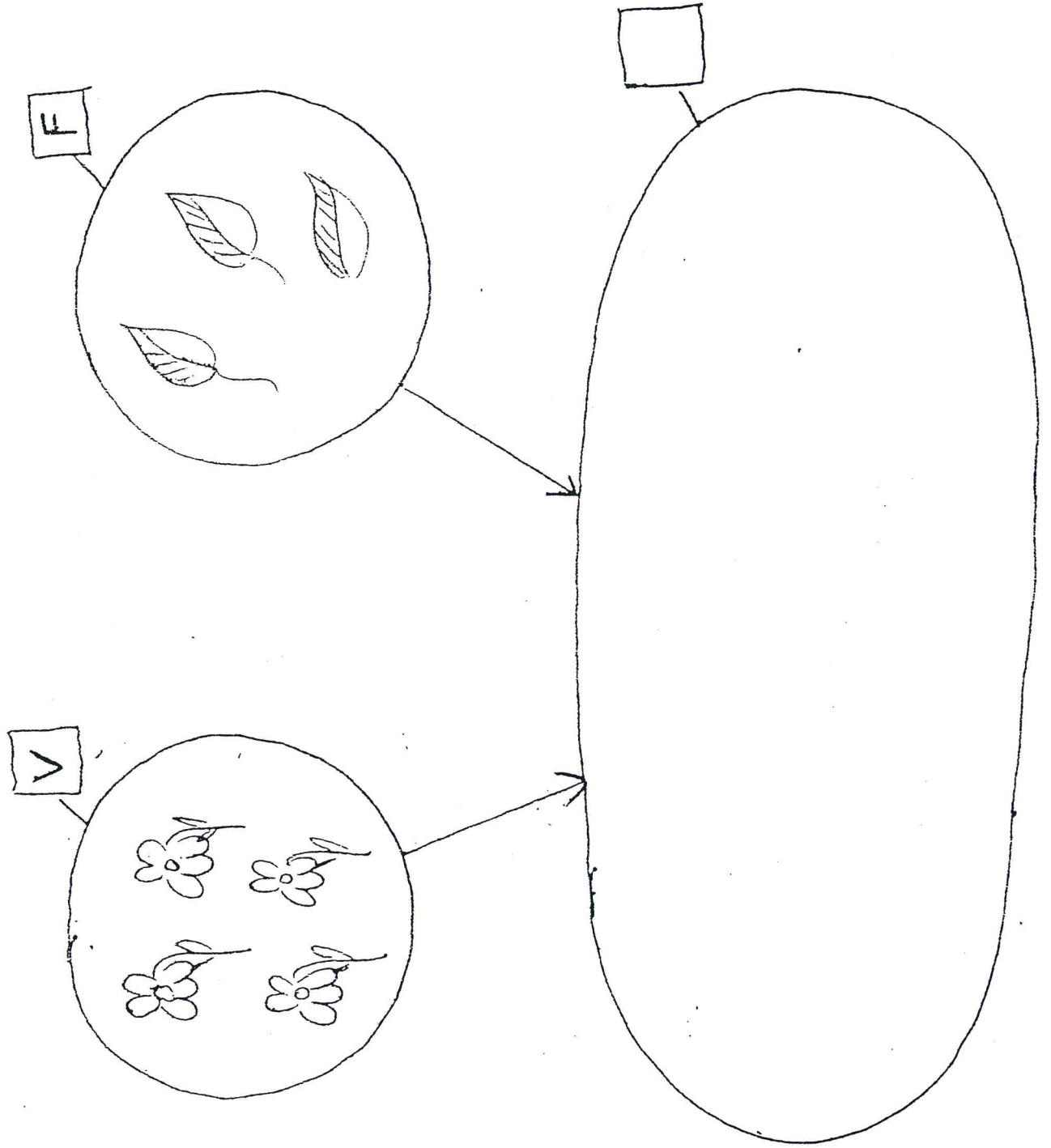

Il presente documento è tratto dal sito web “Documentaria” del
Comune di Modena: <https://documentaria.comune.modena.it>

Titolo: Schede

Sottotitolo: Classe prima

Collocazione: M 21



Comune di Modena



Copyright 2022 © Comune di Modena.

Tutti i diritti sono riservati.

Per informazioni scrivere a: memo@comune.modena.it